



**BULLARD  
SOLAR**  
One with the Sun

**TOTEM + 60**  
**SOLAR STREET LIGHT COLUMN**





**BULLARD  
SOLAR**  
One with the Sun

CODE:  
**BS-TT60-SLX**

FIXTURE TYPE: \_\_\_\_\_

PROJECT NAME: \_\_\_\_\_

**Sleek and efficient from every angle**

Totem (+) redefines solar lighting with a sleek, modern design. Unlike traditional streetlights with bulky top panels, its integrated solar panels remains discreet while ensuring maximum efficiency. Its innovative luminaire provides powerful illumination while optimizing energy capture and autonomy, even in low-light conditions. Available in single or double-headed versions, it can be adapted to both urban and street applications, with quick installation.



Bullard Solar retains the right to modify or change product specifications without prior notice, as part of our ongoing commitment to improvement

**ONE WITH THE SUN**

sales@gordonbullard.com  
www.bullardsolar.com  
1-877-964-4646



991 South Gull Lake Dr  
Richland, MI 49083  
USA

Due to the dynamic nature of lighting products and the associated technologies, luminaire data on all specification sheets is subject to change at the discretion of Gordon Bullard LLC and associated companies.

© Bullard & Company 2024 All Rights Reserved

Updated 07/09/2024



FIXTURE TYPE: \_\_\_\_\_

PROJECT NAME: \_\_\_\_\_



**CERTIFICATIONS**

**IEC / TUV / EMC /  
LM-80 TEST STANDARDS /  
IK08 / IP66 / CE / ULOR /  
UKCA / LVD**

**5  
YEARS**

\* Bullard Solar offers a 5 Years Limited Warranty for the Totem (+) Series luminaire shall be free from defects in material and workmanship for up to five (5) years from date of shipment. This limited warranty covers all components when installed and operated according to Bullard Solar instructions. Fixture suitable for ambient temperature from -10° to 70°. PV Panels - 25 year performance warranty Controller & Batteries: 5 years

NOMINAL FLUX ..... 11760 Lumens  
NOMINAL POWER ..... 60 Watts

**LIGHTING**

Efficiency ..... 196 Lumens/Watts  
Led ..... PHILIPS Luxeon 30-30  
Lifetime ..... Over 100.000 Hrs - LM80  
Optics/CCT ..... T1 / TII / TIII / T-IV / T-V / T10 / T35 - 2300 to 6500K  
Light Height ..... 6,1 m

**BATTERY**

Technology ..... Lithium Iron Phosphate LIFEPO4  
Capacity ..... 1062Wh  
Autonomy ..... Over 24 hours at full charge 4 Rainy Days back up  
Charging time ..... 6-7 Hours  
Lifespan ..... Over 8000 CYCLES - 30% DOD / Over 10y lifetime  
Working temp ..... -10°C to 70 °C (optional -40°C TO 70°C )

**ENERGY**

Solar panel Vertical .... 330 Watts / 18V  
Solar panel Horizontal 52 Watts / 18V  
Cells type ..... Monocrystalline Panel Grade A 25 years  
Certificate ..... IEC 61215 - IEC 61730 I and II - IEC 60904

**ELECTRONIC**

Controller ..... MPPT Controller, (Bullard Solar Bridge Optional)  
Sensor ..... Microwave 360° Sensor  
Cabling ..... Waterproof Connector, (Plug and Play)  
Protection ..... Battery Management System (BMS)

**MECHANICAL**

Wind speed ..... 160km/h  
Material ..... Aluminium and Stainless Steel

**DIMENSIONS**

Product ..... 236.22" (600 cm) x 12.20" (31 cm) x 14.57" (37 cm)  
Carton size ..... 240.16" (610 cm) x 13.00" (33 cm) x 11.02" (28 cm)  
Net Weight ..... 78 KG (49,60 lb)  
Gross Weight ..... 80 KG (60,53 lb)

**ONE WITH THE SUN**

sales@gordonbullard.com  
www.bullardsolar.com  
1-877-964-4646



991 South Gull Lake Dr  
Richland, MI 49083  
USA



**BULLARD  
SOLAR**  
One with the Sun

CODE:  
**BS-TT60-SLX**

FIXTURE TYPE: \_\_\_\_\_

PROJECT NAME: \_\_\_\_\_

**LUMINAIRES & LEDS**  
11760 Lumens - 2300 to 6500 K

The innovative luminaire features an integrated solar panel, while its versatile optics offer adaptable lighting solutions. Constructed from extruded low-copper aluminum with IP66 protection, it guarantees durability. Its AKZO NOBEL Polyester Powder coating enhances resistance to salt, humidity, and UV exposure, ensuring long-lasting performance.

Fitted with PHILIPS LUXEON HE PLUS high-efficiency chips, this luminaire achieves an impressive 196 lumens per watt output. Totem (+) also complies with strict ULR (Upward Light Ratio) standards, effectively minimizing light pollution while delivering optimal illumination performance.

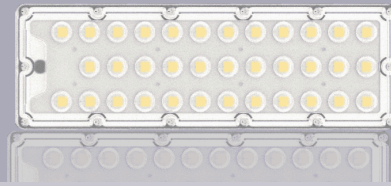

Led: 3030 | LedQ.(Pcs): 72 | Optics: 4 | CRI>70

**LUXEON**  
BY PHILIPS LUMILED

### DIFFERENTS OPTICS AVAILABLE

our different optics will allow you to optimize the lighting results of your projects.

(please contact us for more optics)

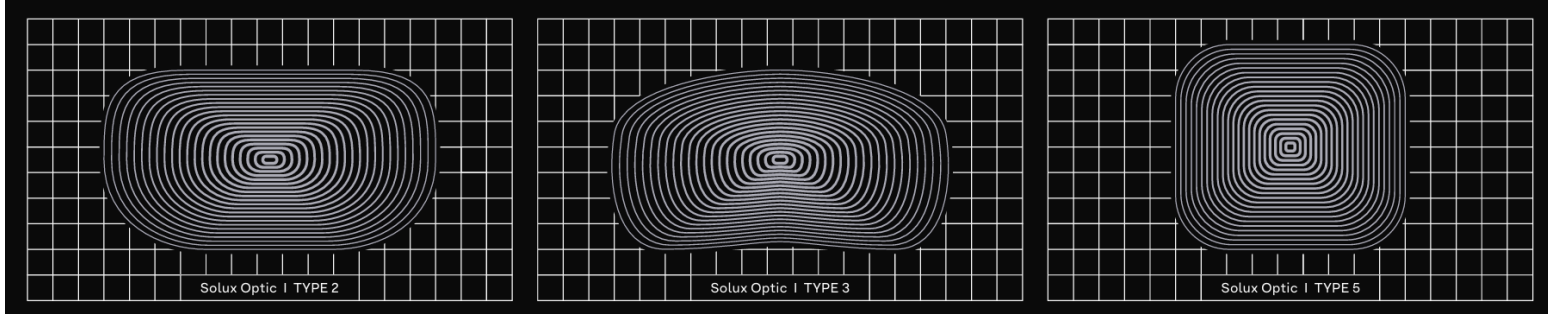

### LIGHT DISTRIBUTION CURVES

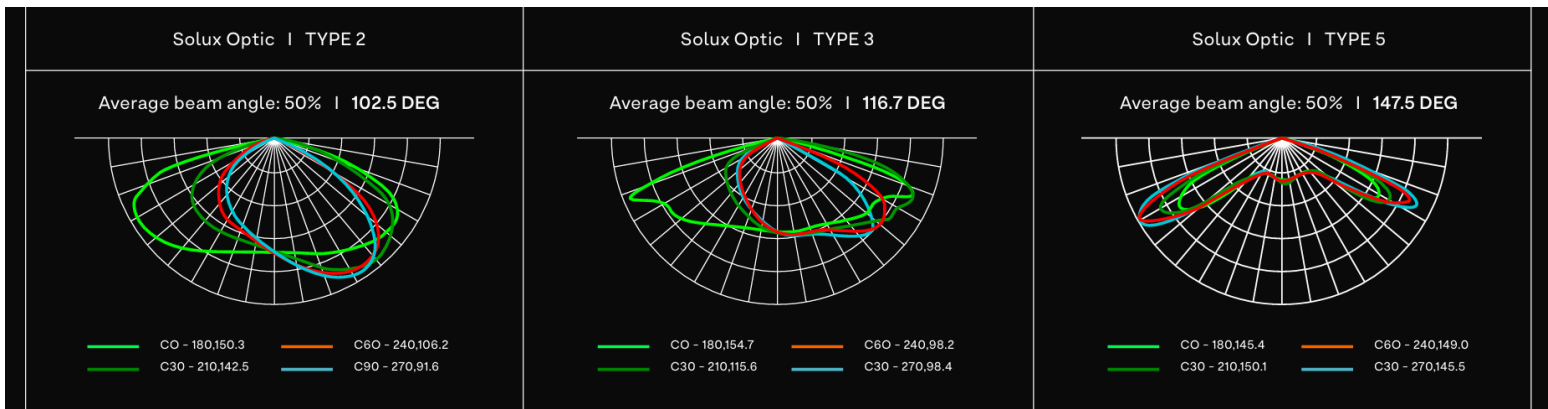

**ONE WITH THE SUN**

sales@gordonbullard.com  
www.bullardsolar.com  
1-877-964-4646



991 South Gull Lake Dr  
Richland, MI 49083  
USA

Due to the dynamic nature of lighting products and the associated technologies, luminaire data on all specification sheets is subject to change at the discretion of Gordon Bullard LLC and associated companies.

© Bullard & Company 2024 All Rights Reserved

Updated 07/09/2024

FIXTURE TYPE: \_\_\_\_\_

PROJECT NAME: \_\_\_\_\_

## BATTERY LIFEPO4 Made to last

The TOTEM (+) series is equipped with Iron Phosphate Lithium LiFePo4 battery. This technology is proved to be the best chemical technology for solar application on the market.

With a cycle life of over 8000 Cycles @ 30% DOD, the battery enjoys lifespan of over 10 years.



**Extreme conditions ready**  
-10° to 70° ( optional - 40° )

### BMS System by Bullard Solar

#### Electronic battery management system

Our batteries are equipped with electronic circuit boards for a higher protection

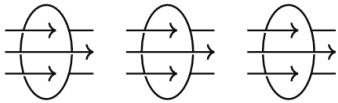

Over & Under current - Overload  
Over & Under Voltage - Over & Under Charge  
Temperature management

DIRECT BATTERY ACCESS | ANTI THEFT SCREW 

**13+y**  
LIFETIME

Aluminium  
Box



## COMPARISON OF DIFFERENT BATTERY TECHNOLOGIES

Lifetime & cycles at 30% DOD



Solux LIFEPO4



8000 cycles

Lead Acid



800 cycles

Nimh



2000 cycles

Lithium Ion



3500 cycles

Charging temperature range without capacity loss

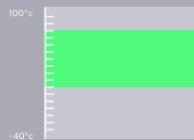
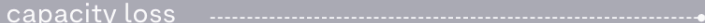

-10 to 70°

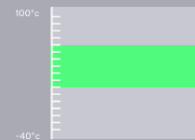

-10 to 50°

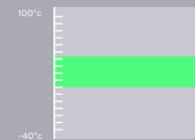

-10 to 50°

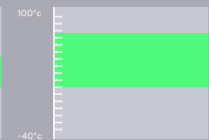

-10 to 65°

### ONE WITH THE SUN

sales@gordonbullard.com  
www.bullardsolar.com  
1-877-964-4646



991 South Gull Lake Dr  
Richland, MI 49083  
USA

FIXTURE TYPE: \_\_\_\_\_

PROJECT NAME: \_\_\_\_\_

# MICROWAVE SENSOR

## Light when you need

### Motion sensor Microwave

The microwave detectors are directly integrated in the luminaires, which use the Doppler effect to detect and quantify the distance of adjacent objects, much like car radars do. In order to evaluate and reflect off of nearby objects, the sensor sends out a high frequency pulse.

- Much better reliability compared to the Infrared detector
- Up to 360° Directivity
- Insensitivity to other environmental variations such as light, color, temperature, etc.

In addition to automatic switching on and off, you have the possibility of choosing among different modular operating modes according to the needs of the project

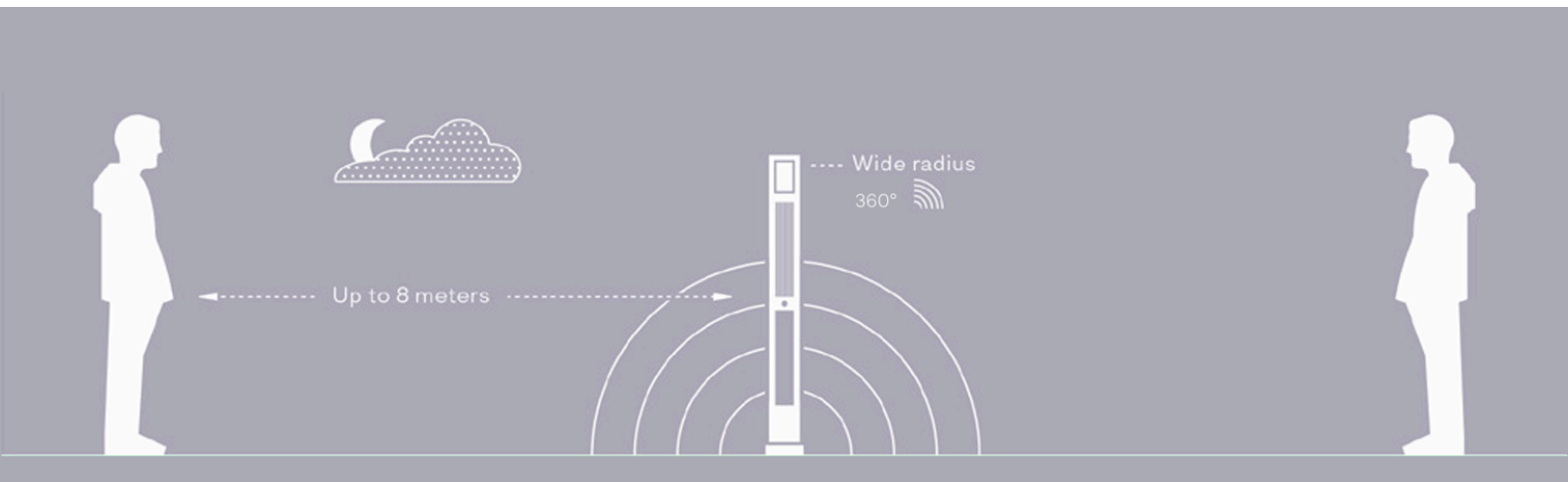

## OPERATION MODE AND LIGHTING SCHEDULE

In addition to automatic switching on and off, you can choose from different modular operating modes to suit the specific needs of your project. So, whether your project demands part-night brightness, early evening lighting, or anything in between, our flexible lighting programs have you covered!

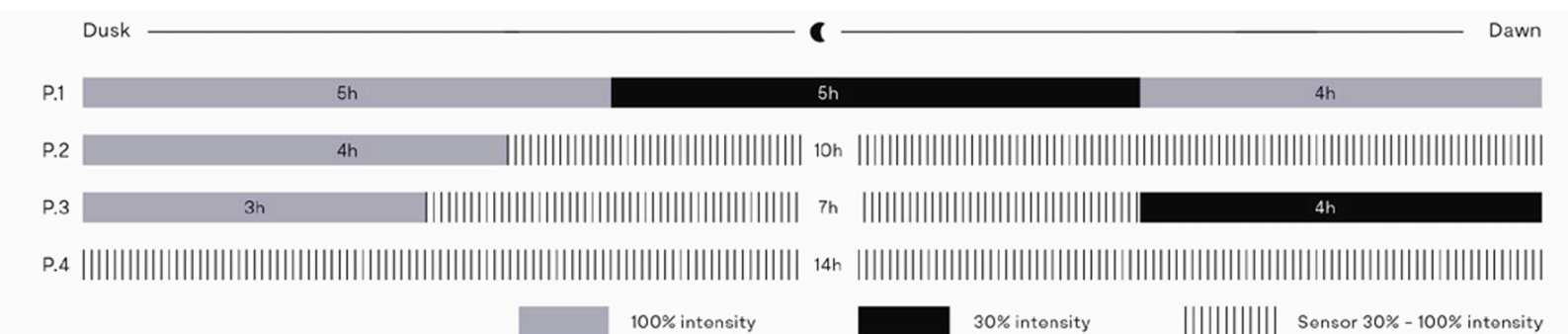

### ONE WITH THE SUN

sales@gordonbullard.com  
www.bullardsolar.com  
1-877-964-4646



991 South Gull Lake Dr  
Richland, MI 49083  
USA

FIXTURE TYPE: \_\_\_\_\_

PROJECT NAME: \_\_\_\_\_

# HORIZONTAL & VERTICAL SOLAR PANEL

Invisible Solar Panels

**Total Solar Panel: 382 W**

For top-tier performance and a sleek design, Totem (+) features SHINGLED PERC photovoltaic technology, with solar panels integrated into both its structure and luminaire. This cutting-edge system ensures exceptional efficiency, even in low-light conditions, while maximizing power output. With seamless integration and no visible connections, TOTEM+ blends effortlessly into any environment, ensuring both functionality and aesthetic appeal.

## POWER LOSS DUE TO SHADING

Conventional panel



Shingled Perc



## DISCRETION

With no visible connections or circuits, Totem (+) is fully integrated into its environment and most people will not notice the presence of solar panels.

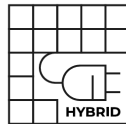

Hybrid system

## PV PERFORMANCE

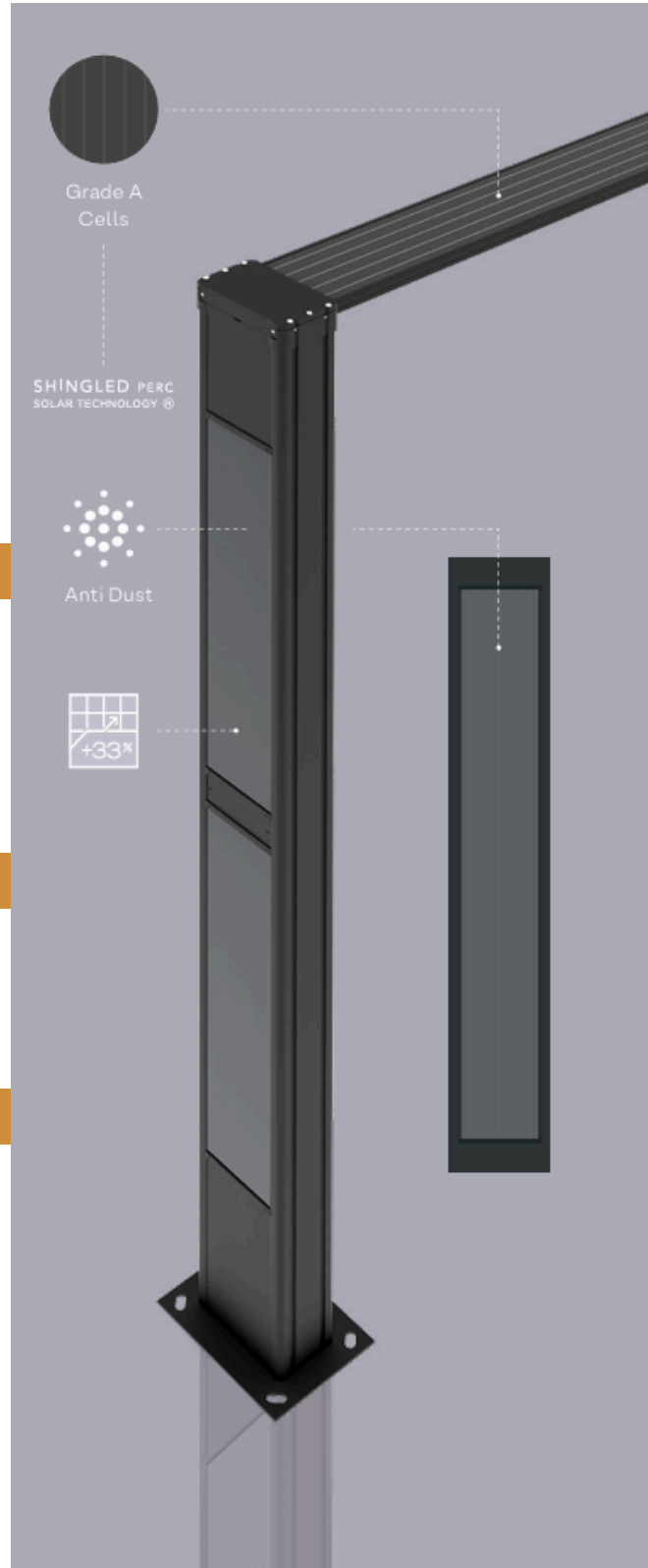
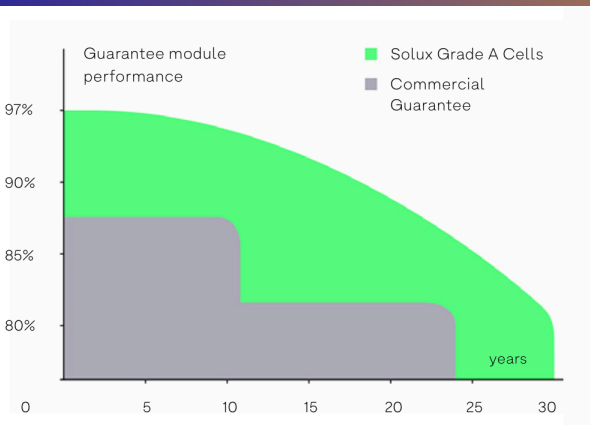

ONE WITH THE SUN

sales@gordonbullard.com  
www.bullardsolar.com  
1-877-964-4646



991 South Gull Lake Dr  
Richland, MI 49083  
USA

FIXTURE TYPE: \_\_\_\_\_

PROJECT NAME: \_\_\_\_\_

# ELECTRONIC

## Control & maintenance

### Remote control



In order to facilitate all maintenance operations: (Bullard Solar exclusivity)

Real time diagnosis

+

Diagnosis of issue  
State of charge  
Production history  
Temperature history

### MPPT Controller

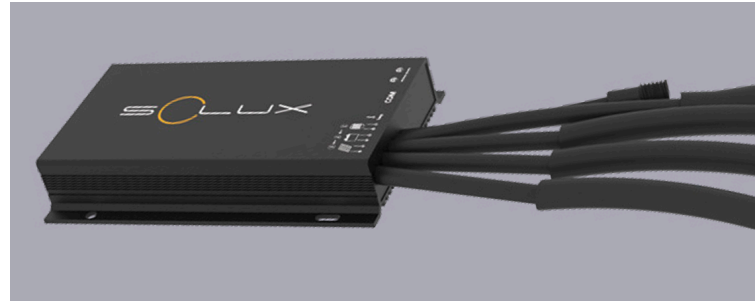

Waterproof connectors |  
Performance & reliability  
Up to 98% efficiency

### BULLARD SOLAR BRIDGE REMOTE MONITORING (OPTIONAL)

As part of our continuous effort for development, Bullard Solar team is proud to have developed a special tool for remote monitoring of our solar street light. Bullard Solar Bridge uses low frequency technology LORA or 2,4 Mesh to monitor in real time a batch of solar street lights.



sales@gordonbullard.com  
www.bullardsolar.com  
1-877-964-4646



991 South Gull Lake Dr  
Richland, MI 49083  
USA

FIXTURE TYPE: \_\_\_\_\_

PROJECT NAME: \_\_\_\_\_

# Technical drawing Model I 60

## Product Dimensions

Easy installation | No cabling - No tranching

Totem (+) is a pole itself, delivered in a single piece which makes it extremely easy to install.

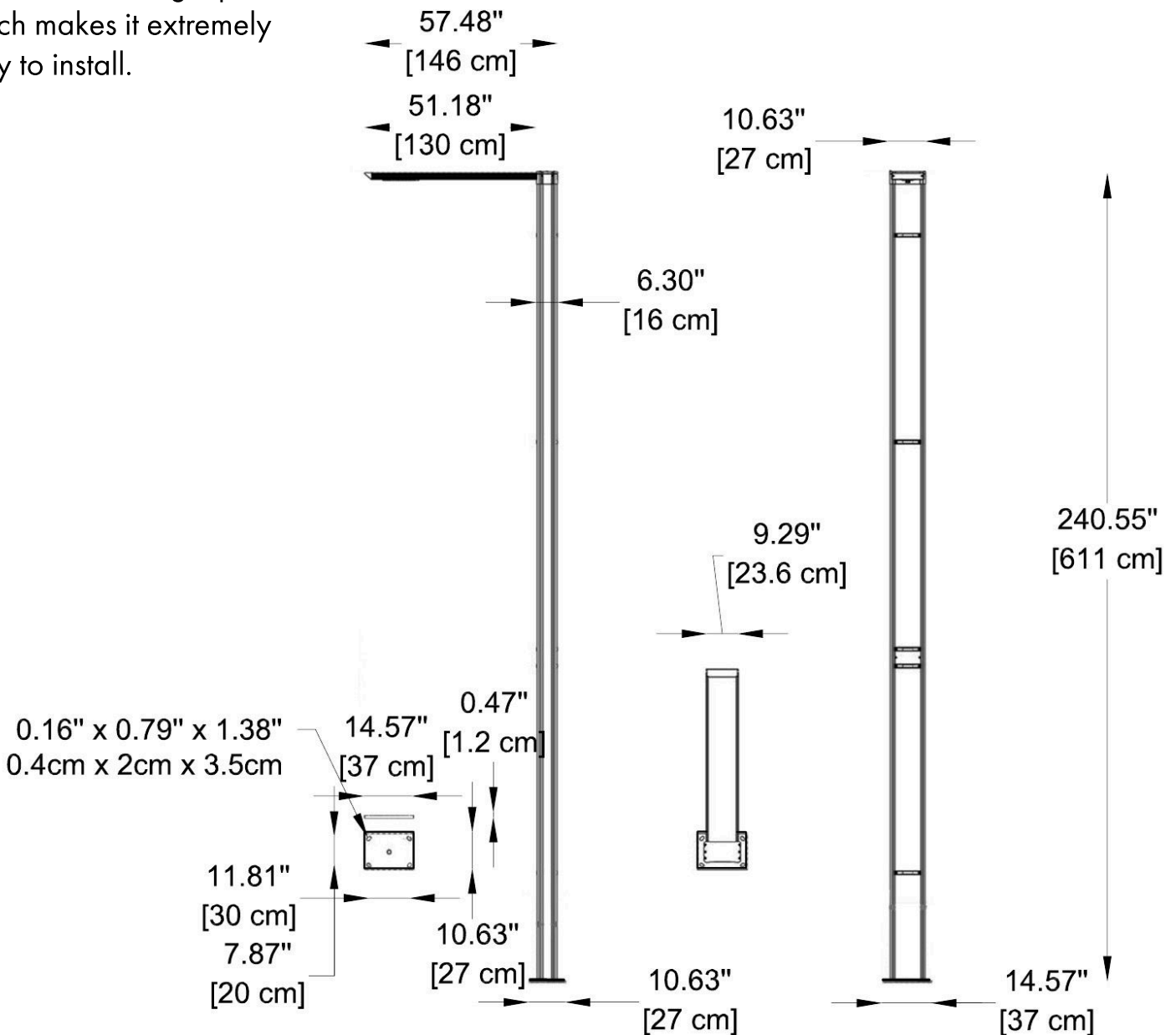

ONE WITH THE SUN

sales@gordonbullard.com  
www.bullardsolar.com  
1-877-964-4646



991 South Gull Lake Dr  
Richland, MI 49083  
USA



FIXTURE TYPE: \_\_\_\_\_

PROJECT NAME: \_\_\_\_\_



**HOW TO ORDER:**

**CODE:**

**Example:**  
CODE: BS-TT60-SLX-30K

BS-TT60-SLX-30K

**1 DIMENSIONS:**

236,22" (600 cm) x 12.20" (31 cm) x 14.57" (37 cm)

**3 CCT:**

- 23K      2300K
- 30K      3000K
- 40K      4000K
- 50K      5000K
- 65K      6500K

**ONE WITH THE SUN**

sales@gordonbullard.com  
www.bullardsolar.com  
1-877-964-4646



991 South Gull Lake Dr  
Richland, MI 49083  
USA