

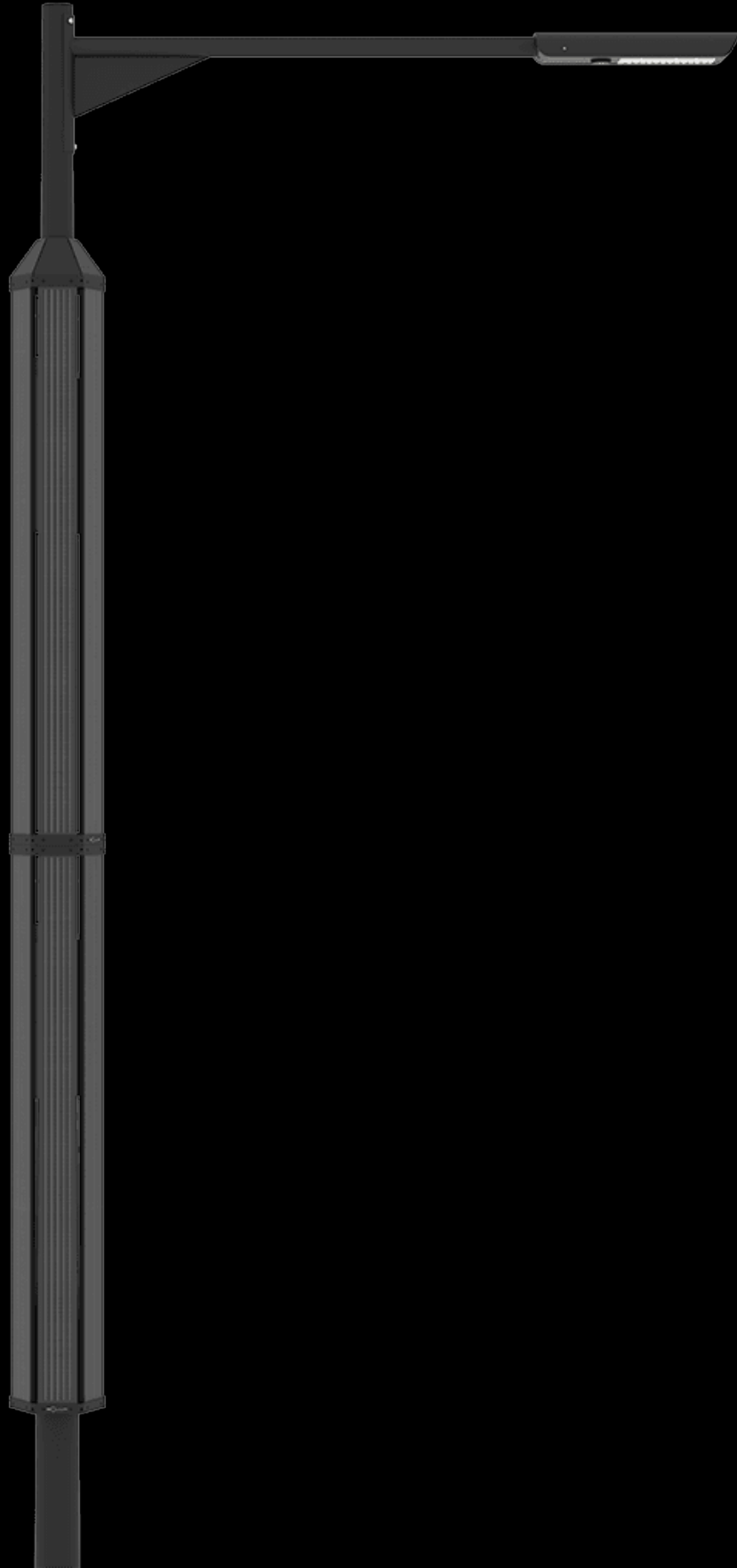

**BULLARD
SOLAR**
One with the Sun

COLARSUN 90 VERTICAL SOLAR STREET LIGHT



FIXTURE TYPE: _____

PROJECT NAME: _____

INTRODUCTION

integrated solar street light



Hello Vertical lighting,

While creating the COLARSUN we wanted a solar street light easy to install, requiring no maintenance or cleaning. Our aim was also to create a solution that could bring retrofit ting to the next level with turning existing energy consum ing and inefficient light point to sustainable solar powered at a realistic cost. After months of hard work, our team of experts developed COLARSUN solar street light, which not only meets all of these criteria, but also boasts a sleek and modern design.

Suitable for



Certified by

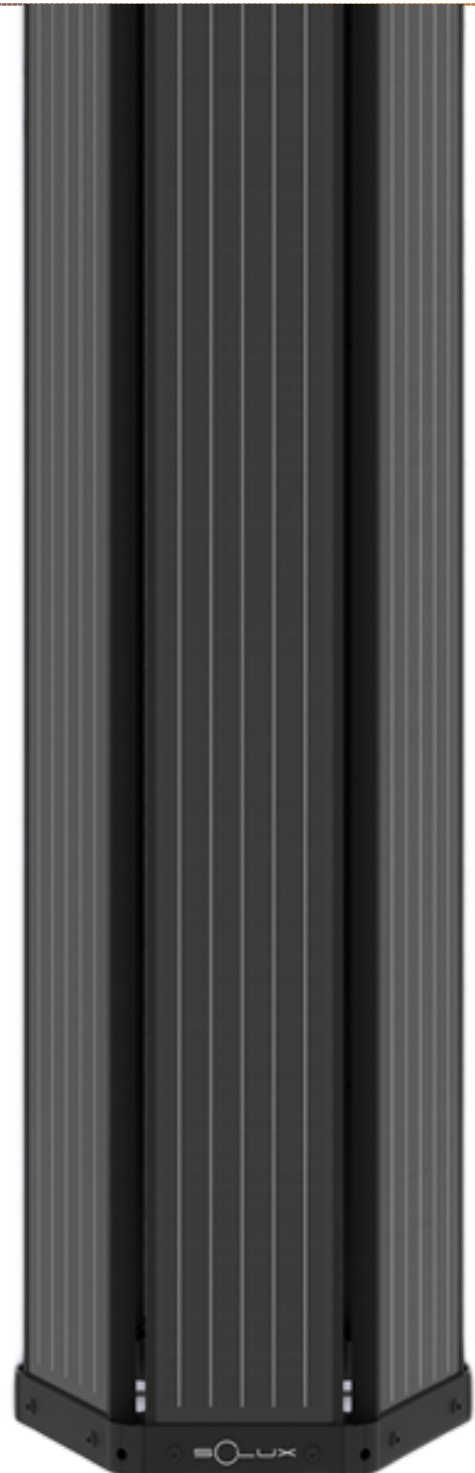

Bullard Solar retains the right to modify or change product specifications without prior notice, as part of our ongoing commitment to improvement

ONE WITH THE SUN

sales@gordonbullard.com
www.bullardsolar.com
1-877-964-4646



991 South Gull Lake Dr
Richland, MI 49083
USA

FIXTURE TYPE: _____

PROJECT NAME: _____



CERTIFICATIONS **IEC / TUV / EMC/ LM-79- 08
AND LM-80 TEST STANDARDS
/ IK8 / IP68 / CE / ULOR**



*Bullard Solar offers a 5 Years Limited Warranty for the Colarsun Series luminaire shall be free from defects in material and workmanship for up to five (5) years from date of shipment. This limited warranty covers all components when installed and operated according to Bullard Solar instructions. Fixture suitable for ambient temperature from -10° to 70°. PV Panels - 25 year performance warranty Controller & Batteries : 5 years

NOMINAL FLUX	17640 Lumens
NOMINAL POWER	90 watts

LIGHTING

Efficiency	196 Lumens/Watts
Led	PHILIPS Luxeon 30-30
Lifetime	Over 100.000 Hrs - LM80
Optics/CCT	TI / TII / TIII / T-IV / T-V / T10 / T35 - 2300 to 6500K
Light Height	From 8 to 10 meters

BATTERY

Technology	Lithium Iron Phosphate LIFEPO4
Capacity	1842 Wh
Autonomy	Over 24 hours at full charge 4 Rainy Days back up
Charging time	5/6 Hours
Lifespan	Over 5000 CYCLES @ 50% DOD over 10y lifetime
Working temp	-10°c to 70°c (optional -40°c TO 70°c)

ENERGY

Number of Colarsun	3
Solar panel	195 W
Option	Hybrid System
Cells type	TOPCON Monocrystalline Panel Grade A 25 years
Certificate	IEC 61215 - IEC 61730 I and II - IEC 60904

ELECTRONIC

Controller	MPPT Controller, (Bullard Solar Bridge Optional)
Sensor	Microwave 360° Sensor
Cabling	Waterproof Connector, (Plug and Play)
Protection	Battery Management System (BMS)

MECHANICAL

Wind speed	76 mm to 100 mm
Material	Aluminium

DIMENSIONS

Solar Panel	198.65" (504.56) cm x 11.14" (28.3 cm) x 9.92" (25.2 cm)
Led Fixture	23.62" (60 cm) x 6.02" (15.3 cm) x 3.19" (8.1 cm)
Carton size	3 x 68.50"(174 cm) x 15.75"(40 cm) x 14.17"(36 cm) 26.38" (67 cm) x 8.66" (22 cm) x 7.09" (18 cm)
Net weight	65,75 KG
Gross weight	76,25 KG
Qty / Ctn 20" / 40"	35 / 86

ONE WITH THE SUN

sales@gordonbullard.com
www.bullardsolar.com
1-877-964-4646



991 South Gull Lake Dr
Richland, MI 49083
USA



**BULLARD
SOLAR**
One with the Sun

CODE:
BS-CS-90-SLX

FIXTURE TYPE: _____

PROJECT NAME: _____

Colarsun concept
Easy installation - Plug & play

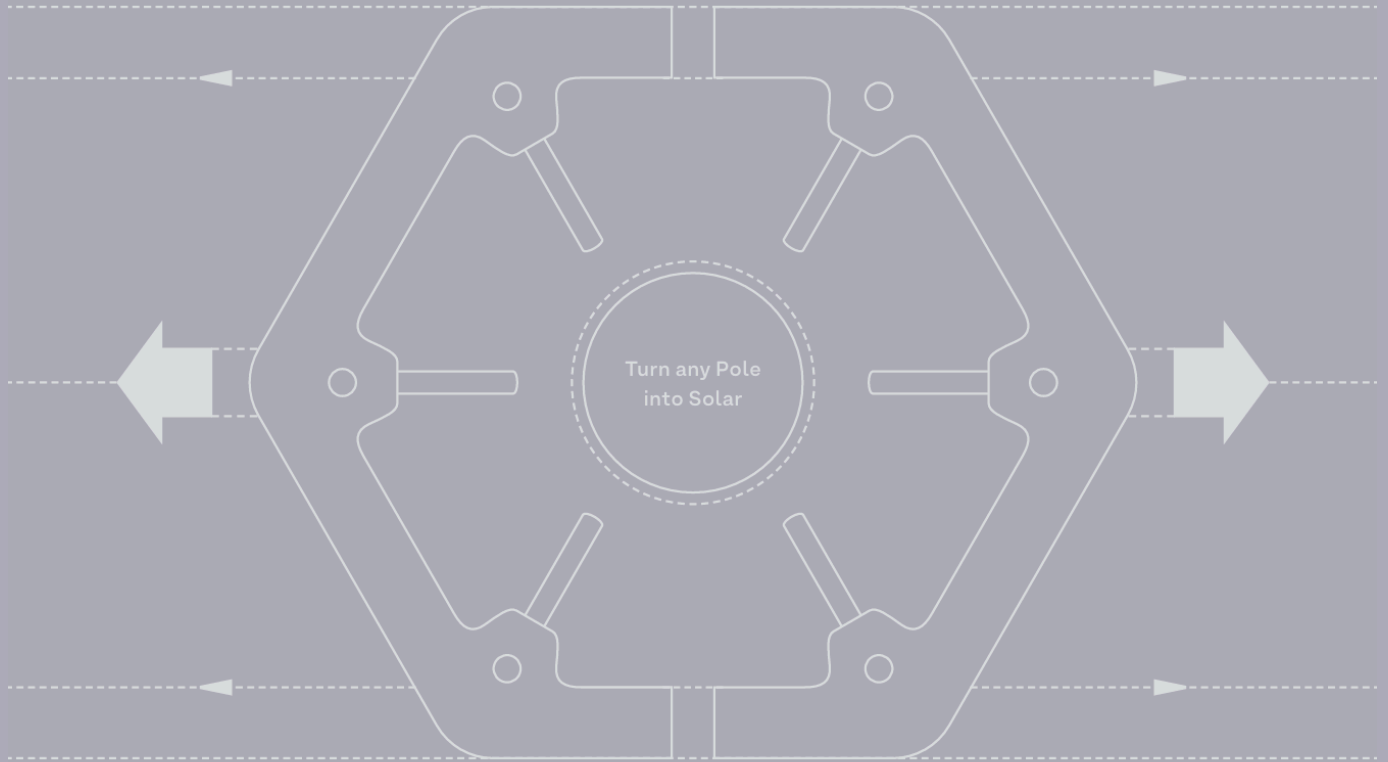

Plug & Play | One man job installation



Installation Step - 1

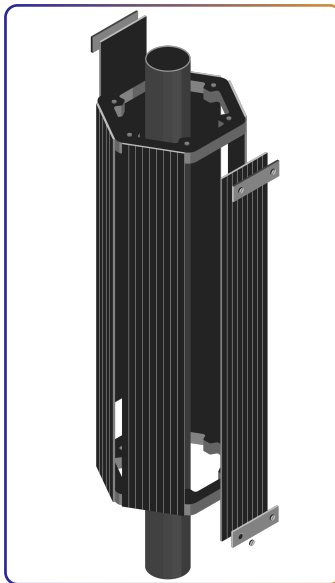

Installation Step - 2

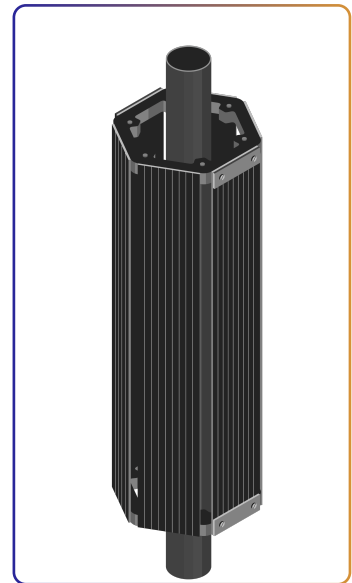

Installation Step - 2

ONE WITH THE SUN

sales@gordonbullard.com
www.bullardsolar.com
1-877-964-4646



991 South Gull Lake Dr
Richland, MI 49083
USA

Due to the dynamic nature of lighting products and the associated technologies, luminaire data on all specification sheets is subject to change at the discretion of Gordon Bullard LLC and associated companies.

© Bullard & Company 2024 All Rights Reserved

Updated 07/09/2024



**BULLARD
SOLAR**
One with the Sun

CODE:
BS-CS-90-SLX

FIXTURE TYPE: _____

PROJECT NAME: _____

Features and advantages

Hassle free maintenance

The unconventional vertical solar panels that ensure fewer dirt deposits and low cleaning maintenance requirements enable COLARSUN to offer the best performances consistently in any conditions. This unique and smart design makes Colarsun the perfect solution for arid desert climate.

All in one system

Enjoy a hassle free maintenance with COLARSUN exclusive design product range.

Easy
Access

Battery
& Controller



Dustproof Design
& engineering



ONE WITH THE SUN

sales@gordonbullard.com
www.bullardsolar.com
1-877-964-4646



991 South Gull Lake Dr
Richland, MI 49083
USA

Due to the dynamic nature of lighting products and the associated technologies, luminaire data on all specification sheets is subject to change at the discretion of Gordon Bullard LLC and associated companies.

© Bullard & Company 2024 All Rights Reserved

Updated 07/09/2024



**BULLARD
SOLAR**
One with the Sun

CODE:
BS-CS-90-SLX

FIXTURE TYPE: _____

PROJECT NAME: _____

COLARSUN exclusive conception & design allow a sun captation at 360° all along the year maxi mizing the energy capacity of the product.

360° Sun Captation

Colarsun engineering is made to provide a 360° sun exposure allowing an optimum battery charging.

FEATURE AND ADVANTAGES

360° Sun / 365 days a year



360°
solar panels



Grade A
Solar Cells

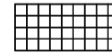

TOPCON
SOLAR TECHNOLOGY ©

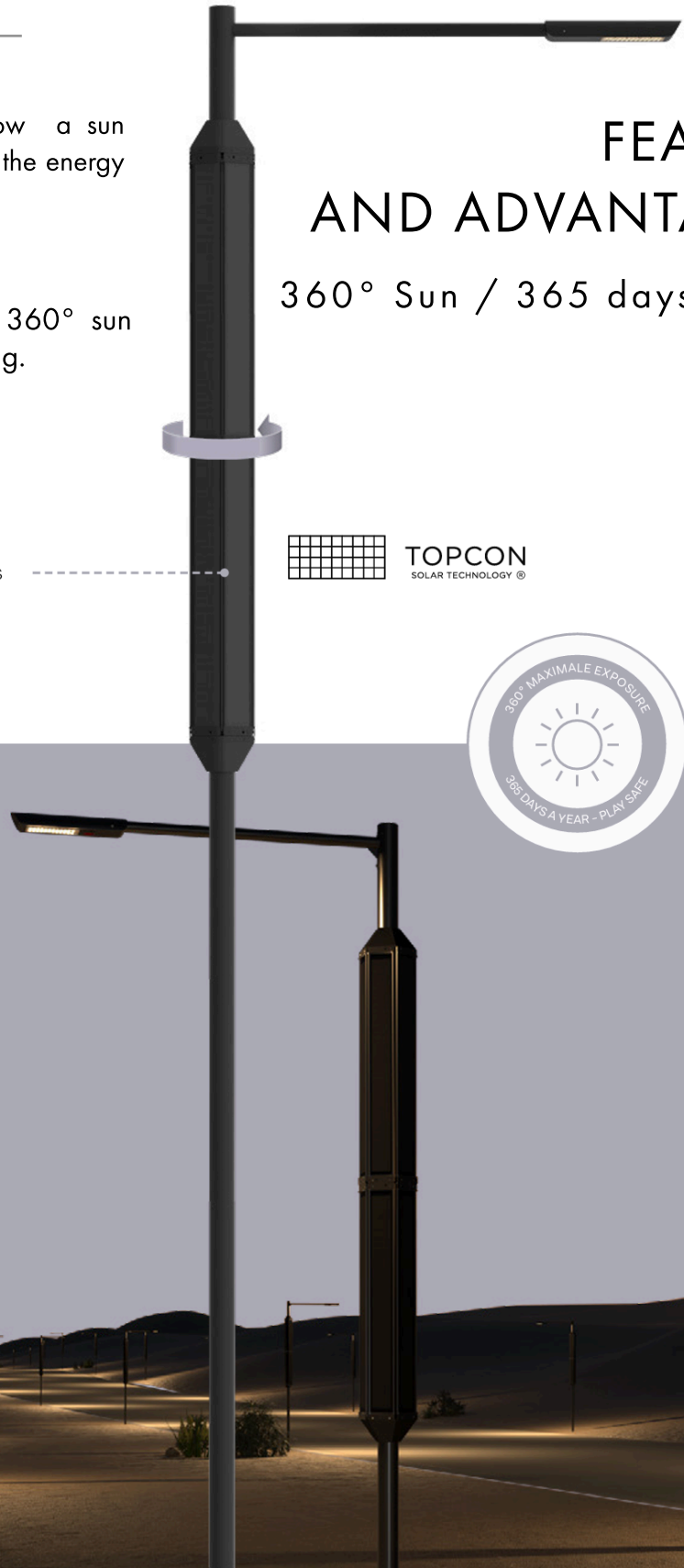
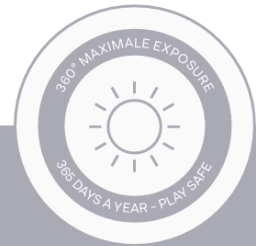

ONE WITH THE SUN

sales@gordonbullard.com
www.bullardsolar.com
1-877-964-4646



991 South Gull Lake Dr
Richland, MI 49083
USA

Due to the dynamic nature of lighting products and the associated technologies, luminaire data on all specification sheets is subject to change at the discretion of Gordon Bullard LLC and associated companies.

© Bullard & Company 2024 All Rights Reserved

Updated 07/09/2024



**BULLARD
SOLAR**
One with the Sun

CODE:
BS-CS-90-SLX

FIXTURE TYPE: _____

PROJECT NAME: _____

LUMINAIRES HOUSING & LEDS

17640 Lumens - 2300 to 6500 K

Our luminaire boasts an anodised aluminium casing, offering exceptional protection with an IP66 rating and superior heat dissipation. Equipped with PHILIPS LUXEON HE PLUS high efficiency chips, it delivers an impressive 196 lumens per watt efficacy.

Furthermore, the luminaire adheres to DARK SKY requirements for light pollution, ensuring minimal upward lighting at just 0.31%.

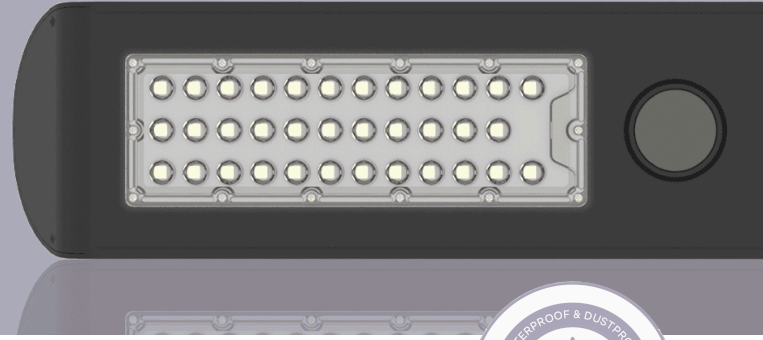

Led : 3030 | Led Q. (Pcs) : 72 | Optics: 1 | CRI > 80

LUXEON
BY PHILIPS LUMILED



DIFFERENTS OPTICS AVAILABLE

our different optics will allow you to optimize the lighting results of your projects.

(please contact us for more optics)

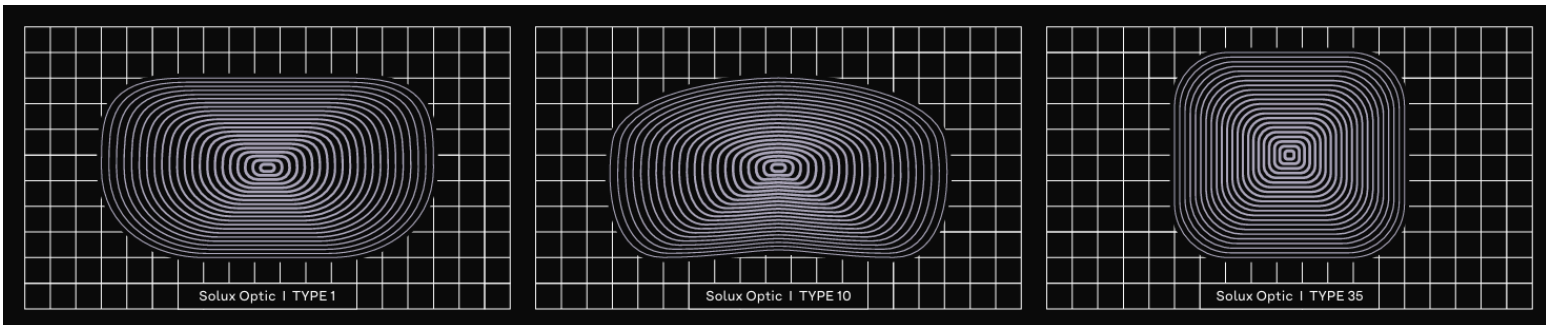

LIGHT DISTRIBUTION CURVES

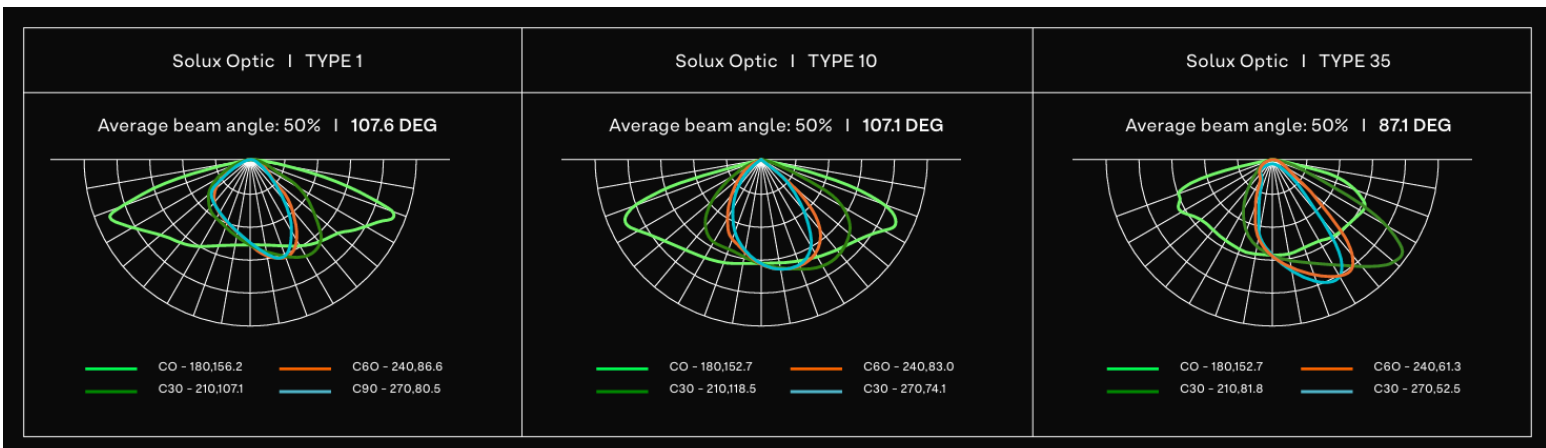

ONE WITH THE SUN

sales@gordonbullard.com
www.bullardsolar.com
1-877-964-4646



991 South Gull Lake Dr
Richland, MI 49083
USA

Due to the dynamic nature of lighting products and the associated technologies, luminaire data on all specification sheets is subject to change at the discretion of Gordon Bullard LLC and associated companies.

© Bullard & Company 2024 All Rights Reserved

Updated 07/09/2024



**BULLARD
SOLAR**
One with the Sun

CODE:
BS-CS-90-SLX

FIXTURE TYPE: _____

PROJECT NAME: _____

BATTERY LIFEPO4 Made to last

Aluminium waterproof casing & Natural Airflow

The COLARSUN series is equipped with Iron Phosphate Lithium LiFePO4 battery. This technology is proved to be the best chemical technology for solar application on the market. With a cycle life of over 5000 Cycles @ 50% DOD, the battery enjoys lifespan of over 13 years.

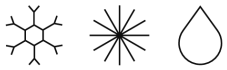

Extreme conditions ready
-10° to 85° (optional - 40°)

BMS System by Bullard Solar

Electronic battery management system

Our batteries are equipped with electronic circuit boards for a higher protection

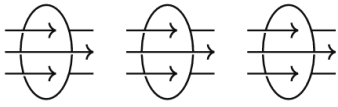

- Over & Under current - Overload
- Over & Under Voltage - Over & Under Charge
- Temperature management

DIRECT BATTERY ACCESS | ANTI THEFT SCREW



High temperatures significantly impact the lifespan of batteries. To address this issue, our batteries are housed in a sealed extruded aluminum enclosure, which is renowned for its excellent heat dissipation properties. With the help of the COLARSUN Structure, natural airflow effectively regulates the temperatures of the components.



Natural Airflow design
Lithium Life.P04 battery

COMPARISON OF DIFFERENT BATTERY TECHNOLOGIES

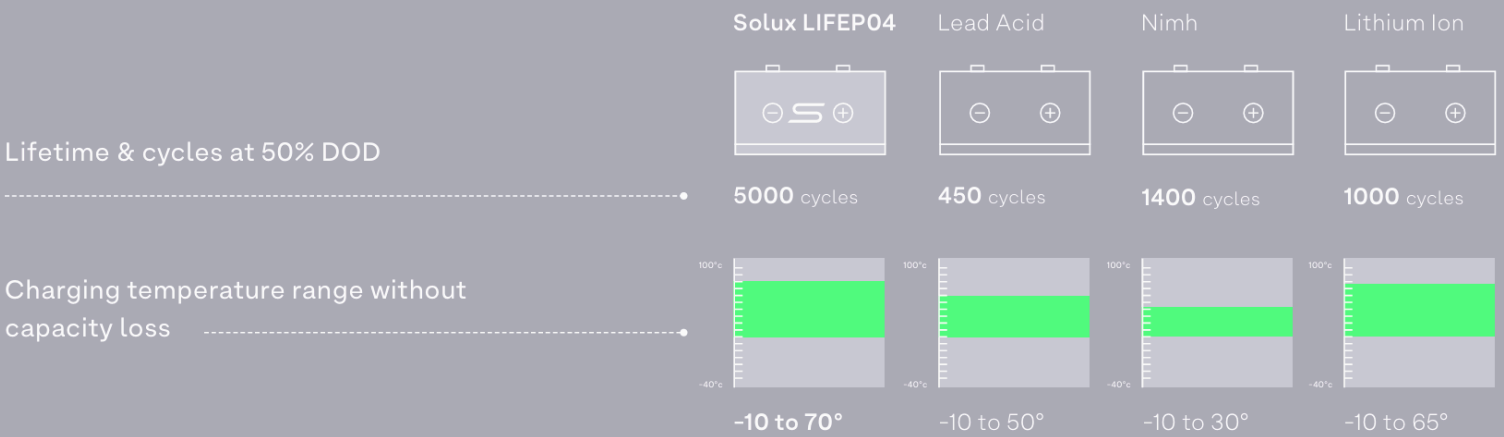

ONE WITH THE SUN

sales@gordonbullard.com
www.bullardsolar.com
1-877-964-4646



991 South Gull Lake Dr
Richland, MI 49083
USA

FIXTURE TYPE: _____

PROJECT NAME: _____

TOPCON MONOCRYSTALINE SOLAR PANEL

Anodized aluminium frame for longevity

For high performance and a sleek design, the COLARSUN lights are equipped with TOPCON photovoltaic technology, providing very high efficiency, as well as improved performance in low irradiation. It allows maximizing the installed power in a limited space. Vertically mounted, they don't accumulate dust ultimately reducing the need for complex and expensive cleaning programs.

TOPCON ADVANTAGES / POWERLOSS DUE TO SHADING

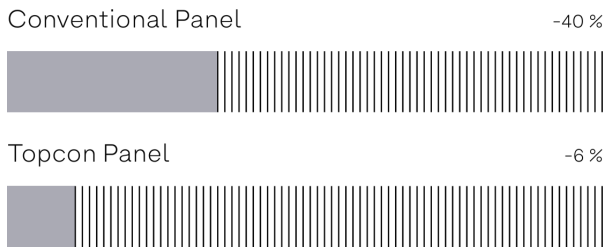

MPPT CONTROLLER

Waterproof connectors | Performance & reliability | Up to 98% efficiency

ANTI BLACKOUT: Load adjust according to the battery capacity & Intelligent LED Driver.

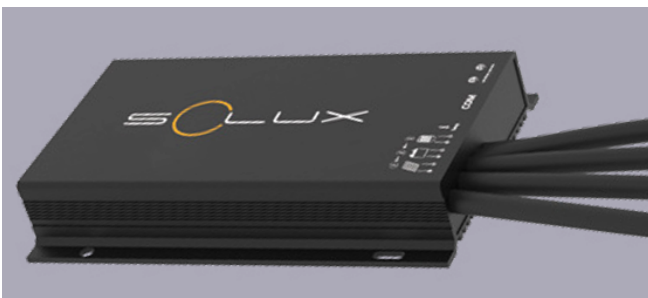

AVAILABLE FOR HYBRID-RETROFITTING

Transform your existing street light into a solar-powered one seamlessly with our Hybrid AC/DC MPPT Controller and MEAN WELL Driver.

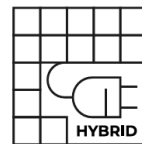

Hybrid system

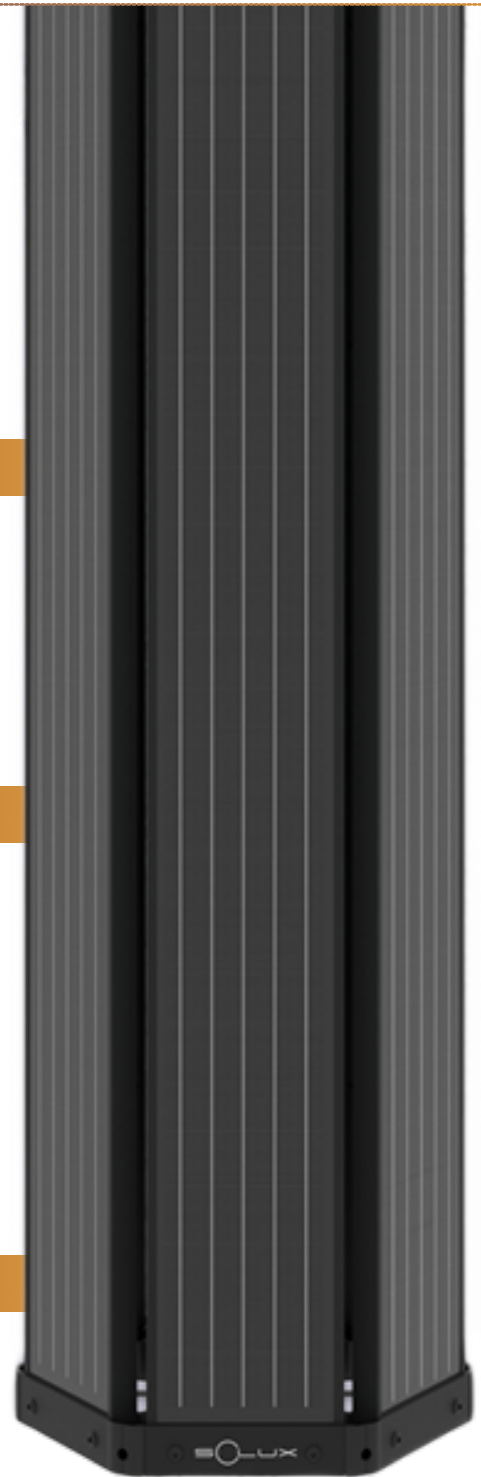

ONE WITH THE SUN

sales@gordonbullard.com
www.bullardsolar.com
1-877-964-4646



991 South Gull Lake Dr
Richland, MI 49083
USA



**BULLARD
SOLAR**
One with the Sun

CODE:
BS-CS-90-SLX

FIXTURE TYPE: _____

PROJECT NAME: _____

MICROWAVE SENSOR

Bullard Solar exclusive sensor

Bullard Solar luminaires are equipped with microwave detectors that use the Doppler effect, just like car radars, to detect nearby objects and measure their distance. The sensor emits a high-frequency wave that reflects off objects, allowing for precise analysis.

Because these microwaves only detect specific objects, our sensors offer increased detection reliability, resulting in:

- Much better reliability compared to the Infrared detector
- Up to 360° Directivity
- Insensitivity to other environmental variations such as light, color, temperature, etc.



Presence detection

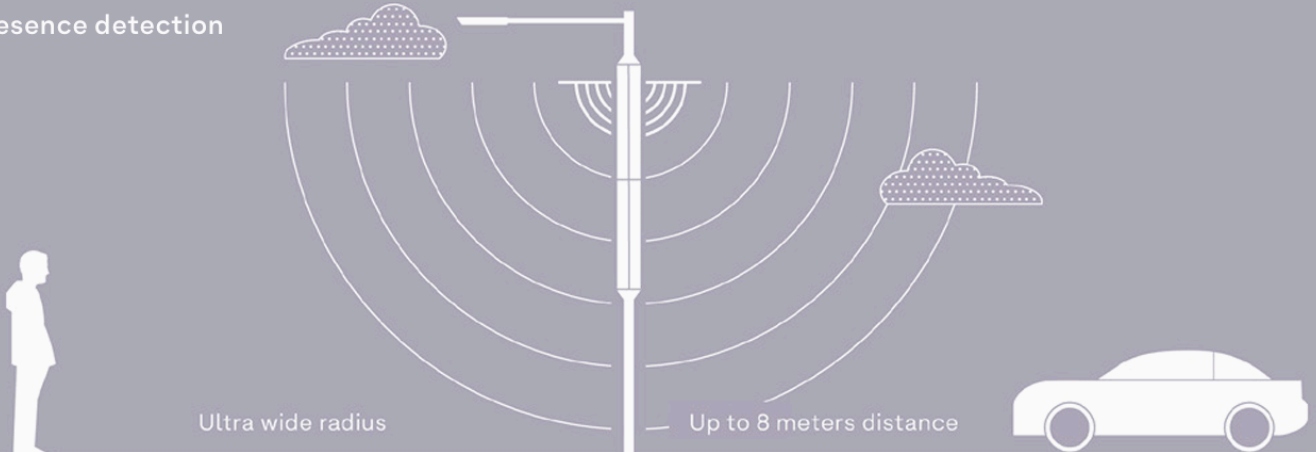

OPERATION MODE AND LIGHTING SCHEDULE

In addition to automatic switching on and off, you can choose from different modular operating modes to suit the specific needs of your project. So, whether your project demands part-night brightness, early evening lighting, or anything in between, our flexible lighting programs have you covered!

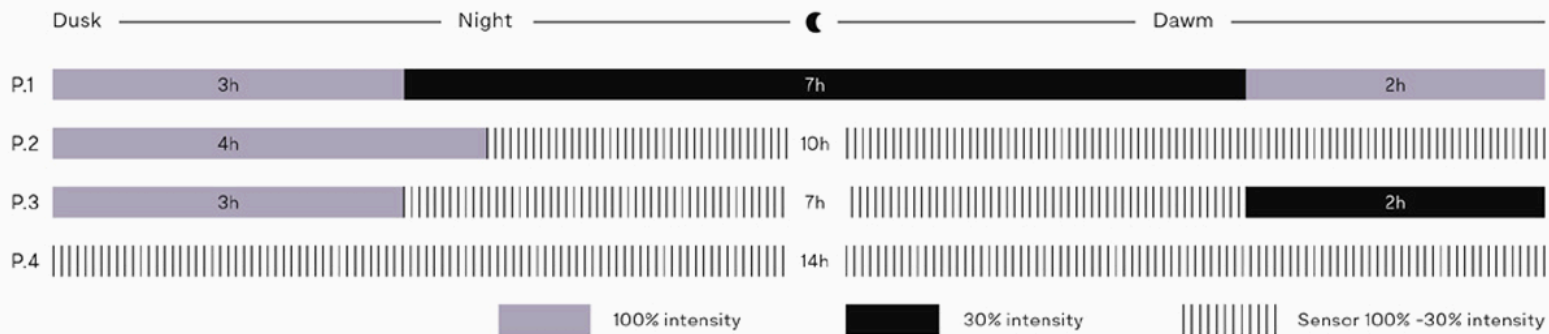

ONE WITH THE SUN

sales@gordonbullard.com
www.bullardsolar.com
1-877-964-4646



991 South Gull Lake Dr
Richland, MI 49083
USA

FIXTURE TYPE: _____

PROJECT NAME: _____

Technical drawing Colarsun 90

Product Dimensions

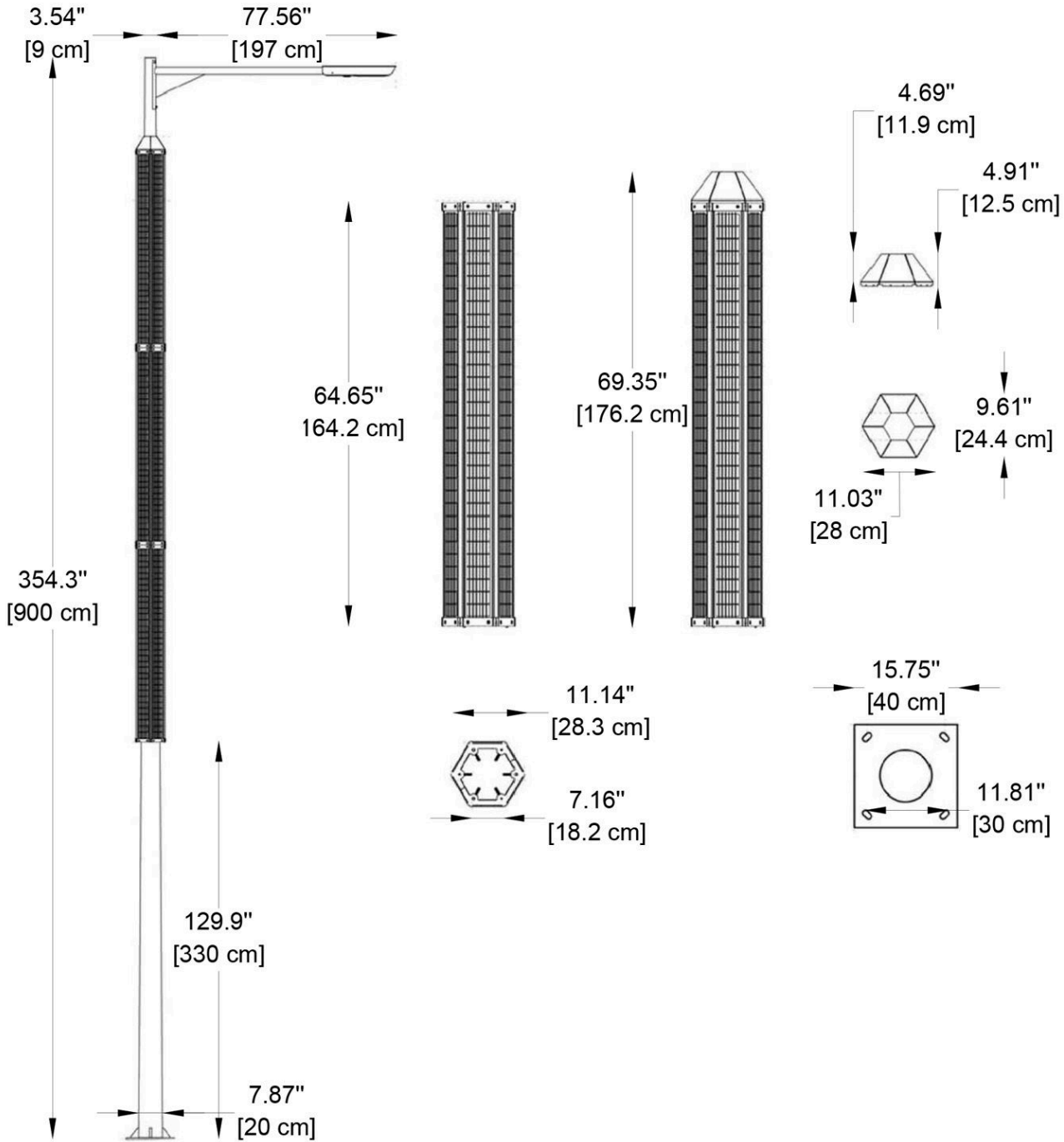

ONE WITH THE SUN

sales@gordonbullard.com
www.bullardsolar.com
1-877-964-4646



991 South Gull Lake Dr
Richland, MI 49083
USA



FIXTURE TYPE: _____

PROJECT NAME: _____



HOW TO ORDER:

CODE:

Example:
CODE: BS-CS-90-SLX-30K

BS-CS-90-SLX-30K

1 DIMENSIONS:

Solar Panel - 198.65" (504.56 cm) x 11.14" (28.3 cm)
x 9.92" (25.2 cm)

Led Fixture - 23.62" (60 cm) x 6.02" (15.3 cm) x 3.19" (8.1 cm)

2 CCT:

- 23K 2300K
- 30K 3000K
- 40K 4000K
- 50K 5000K
- 65K 6500K

ONE WITH THE SUN

sales@gordonbullard.com
www.bullardsolar.com
1-877-964-4646



991 South Gull Lake Dr
Richland, MI 49083
USA