



CORE 4

ROUND, DIRECT ILLUMINATION



SPECIFICATIONS

PROFILE	Round
SIZE	4.5" diameter
LED OUTPUT	500lm - 4,000lm
CCT/CRI	2700K/3000K/3500K/4000K • 90 CRI or BIOS
DIMMING/DRIVER	Internal, Canopy, and Remote Driver: 0-10V, Phase, DALI, DMX, eldoLED, Lutron®, PoE (Molex, Igor, NuLEDs). Dimming to 0% for select models.
POWER	3.4W to 35.5W per fixture
INPUT	100VAC to 277VAC Phase dimmable versions are 120VAC only
OPTICS	15° - 80° distribution spun aluminum reflectors. Field replaceable without tools.
FINISHES	Powder coat - TGIC polyester
MATERIAL	Extruded aluminum with galvanized steel hardware
ENVIRONMENT	Indoor dry or damp locations

WELL

For UGR values and recommended options that contribute to meeting the WELL Building Standard™ see [WELL addendum](#).

*Safety and Performance information available on last page. Output and other specifications available on page 8.

DISTRIBUTIONS & PROFILES

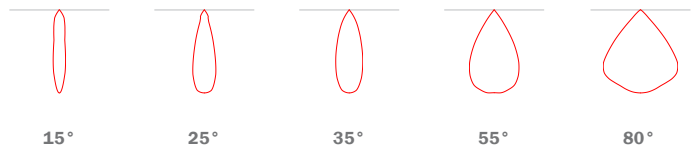

CORE 4 PENDANT



CORE 4 SURFACE MOUNT

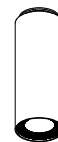

CORE 4 SCONCE



CORE 4 YOKE

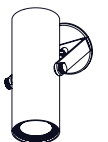

CORE 4 PENDANT

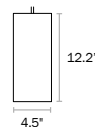

CORE 4 SURFACE MOUNT

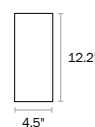

CORE 4 SCONCE

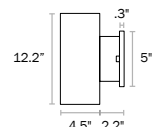

CORE 4 YOKE

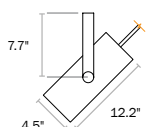

Not to scale. Dimensions are nominal. Consult factory for CAD drawing





PRODUCT SUBMITTAL QUICK WORKSHEET

1	2	3	4	5	6	7	8	9	10	11	12	13
---	---	---	---	---	---	---	---	---	----	----	----	----

EXAMPLE: CRP4 – 20902725HL – RV00 – SG – BK – AC – NLT – EMB

1. MODEL (CHOOSE 1)	2. OUTPUT (CHOOSE 1)	3. CRI* (CHOOSE 1)	4. CCT* (CHOOSE 1)
QS CRP4 Pendant	05² 500lm	QS 90 90	27² 2700K
QS CRM4 Surface Mount	QS 10 1000lm	BD¹ BIOS Dynamic	QS 30 3000K
CRS4 Sconce	QS 15 1500lm	*Dynamic BIOS SkyBlue® 490nm LED can be tuned out with most LED driver and dimmer combinations. See pages 9-10 for details.	QS 35 3500K
CRY4 Yoke	QS 20 2000lm		QS 40 4000K
	QS 25 2500lm		
	QS 30 3000lm		
	QS 35 3500lm		
	QS 40 4000lm		*Not available in BIOS Dynamic.
	*See BIOS Dynamic supplement pages 9-10 for BIOS lamping options.		
	² Available for V01 dimming only.		

5. REFLECTOR (CHOOSE 1)	6. OPTICAL ACCESSORY (CHOOSE 1)	7. DRIVER LOCATION* (CHOOSE 1)	8. DIMMING* (CHOOSE 1)
15 15° (0.3 S/MH)	QS NN None	QS R Remote	V00 (0-10V, dim to 0%)
QS 25 25° (0.4 S/MH)	HL Honeycomb Louver	QS D Deep Canopy	QS V01 (0-10V, dim to 1%)
QS 35 35° (0.6 S/MH)	DF Diffusion Lens	QS N Internal	QS P01 (ELV/TRIAC phase dim to 1%)
QS 55 55° (0.9 S/MH)	LS Linear Spread Lens (60° x 1°)	*See 'Dimming/driver location compatibility' on page 11 to ensure correct dimming specification.	ELDVO² (eldoLED, 0-10V, dim to 0%)
80 80° (1.4 S/MH)	WW Wall Wash Lens (shifts beam 20° from vertical)		LDE1³ (Lutron ECOSYS1, 0-10V, dim to 1%)
¹ Beam angles noted above are nominal.			DALI² (DALI, dim to 0%)
			DMX² (DMX, dim to 0%)
			POEM³ (POE Moxex)
			POEI³ (POE IGOR)
			POEN³ (POE Nuleds)
			POE^{3,4} (POE Ready)
			⁵ See 'Driver', 'Sensor', and 'dimming/driver compatibility charts for sensor and dimming compatibility.
			⁶ Consult factory for BIOS Dynamic dimming options.
			⁷ Not available with internal driver (N) location.
			⁸ POE drivers only compatible with remote driver (R) location. Driver size may change depending on lumen package.
			⁹ Choose if desired PoE solution not listed. Contact customer service to review and confirm the PoE system of your choice.

9. SHELL COLOR* (CHOOSE 1)	10. SUSPENSION* (CHOOSE 1)	11. SUSPENSION OPTIONS* (OPTIONAL CHOOSE 1)	12. SENSOR OPTIONS* (OPTIONAL CHOOSE 1)
FINISHES**	PENDANT STYLE	PENDANT OPTIONS	WLNX (Cooper Wavelinx, remote)
QS SG <input type="checkbox"/> Silver Gray	QS BK³ Black Cord	AC Aircraft Cable	QS ENLGH (Enlighted, remote)
QS SW <input type="checkbox"/> Satin White	QS WH³ White Cord	SB⁷ Seismic Bracing	FCJS (Lutron, remote)
QS SB <input type="checkbox"/> Satin Black	QS CB³ Clear Braided Cord	⁷ Seismic bracing only available for Rigid Stem suspensions.	FCJS/S (Lutron, remote, occ/daylight sensor)
--- Specify Finish Code (Ex: OB = Oil-Rubbed Bronze)	CC__^{3,4,5} Color Cord		MLX (Moxex POE, remote)
SPECIAL ORDER FINISHES**	RS##⁶ Rigid Stem		NLT (nLight wired remote connection)
RAL_____ Specify RAL Classic Color (Ex: RAL 3003) -	SS##⁶ Swivel Stem		NLTAIR (nLight AIR, remote connection, integral occ/daylight sensor)
CAT_____ Specify Catalog Colors	YOKE STYLE		QS OS/PH/HV (Hubbel WASP remote occ/daylight sensor)
CCM_____ Specify Custom Color Match	SC Standard Canopy		⁸ Default quantity is 1 sensor per fixture, type alternate quantity (/##) into product code above if desired and contact ALW to request price adjustment. Sensor descriptions available on page 12.
	RS##⁶ Rigid Stem		⁹ Not all sensors are compatible with all drivers. See 'Driver', 'Sensor' and lamping charts for driver details and sensor compatibility.
	SS##⁶ Swivel Stem		
⁵ See page 6 for finish chart.	³ Selection not required for surface mount and sconce.		
⁶ Manually type the finish code into the parametric code above.	⁴ Standard cord length 6ft. For longer cords, type desired length after cord style in product code above (i.e BK/8 = Black Cord + 8ft cord length)		
	⁵ Available only with Deep or Remote Driver, 0-10V, ECOSYS1, DMX and DALI. Available with deep, remote, and internal driver for ELC/TRIAC phase dimming.		
	⁶ Type code for desired color into product code above (i.e. CC5/8 = Neon Coral cord + 8ft length)		
	⁷ Type desired stem length (4" -100") into product code above.		

13. EMERGENCY OPTIONS* (OPTIONAL)

QS **EMB⁸** Emergency Battery

⁸Emergency options only available with 0-10V driver options. Third party inverter system recommended for other driver options. Refer to [ALW EM Solution Catalog](#) for all compatibility exceptions.
⁹Only canopy and remote mount available.

QS = QuickShip-qualifying option. For the entire luminaire configuration to be QuickShip-eligible, ALL options specified in the configuration must be ones notated with "QS".
 NOTE: Maximum 100 cylinders QuickShip-eligible product per order.

SS021023



DIMENSIONS AND MOUNTING

**CORE 4
PENDANT**

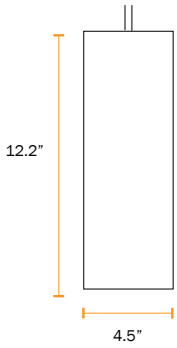

**CORE 4
SURFACE**

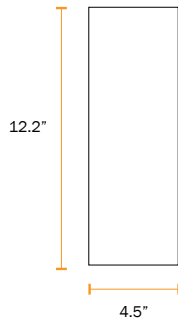

**CORE 4
SCONCE**

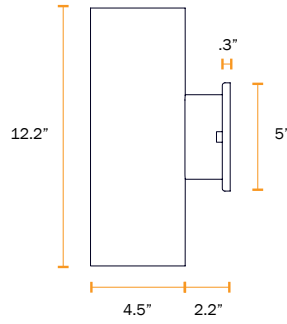

**CORE 4
YOKE**

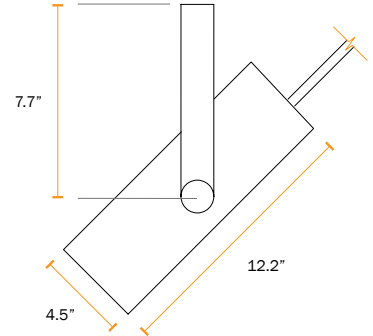

REMOTE DRIVER

STANDARD SHALLOW CANOPY

PENDANT ONLY

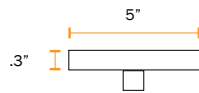

DEEP CANOPY MOUNTED DRIVER¹²

DEEP CANOPY FOR CANOPY MOUNTED LED DRIVERS

PENDANT ONLY

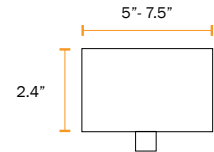
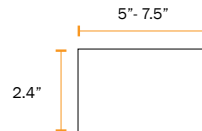

Not to scale. Dimensions are nominal. Consult factory for CAD drawings.
All canopies fit standard 3.5" and 4" round and octagonal junction boxes.
¹²Deep canopy diameter depends on LED driver size



DIMENSIONS AND MOUNTING

YOKE STANDARD CANOPY

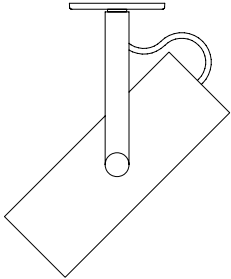

YOKE RIGID STEM

includes 10° hang straight

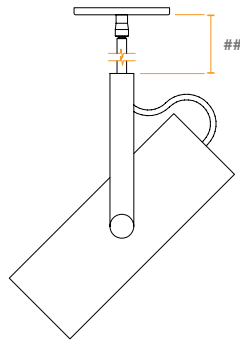

YOKE SWIVEL STEM

360° rotation x 90° tilt swivel

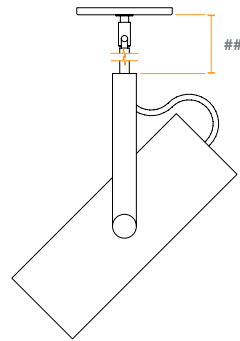

= length in inches from bottom of canopy to top of yoke

PENDANT SUSPENSION OPTIONS

SWIVEL STEM

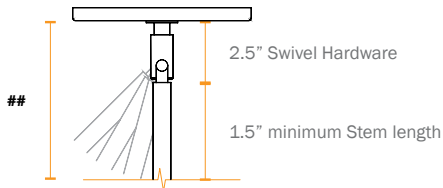

Order Code = **SS##**

= length in inches from bottom of canopy to top of fixture. Includes the swivel hardware. Minimum length for swivel hardware + stem is 4". Total length (##) for swivel hardware alone is 2.5".

360° rotation x 90° tilt swivel

RIGID STEM

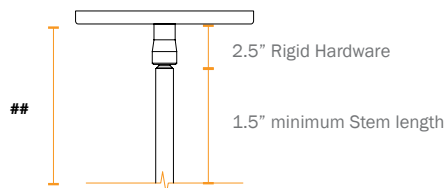

Order Code = **RS##**

= length in inches from bottom of canopy to top of fixture. Includes the rigid hardware. Minimum length for rigid hardware + stem is 4". Total length (##) for rigid hardware alone is 2.5".

Includes 10° hang straight

AIRCRAFT CABLE

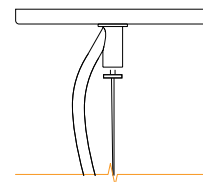

Order Code = **AC**

Standard cable length = 6'
Cable length is field adjustable



FINISHES

BASIC POWDER COAT

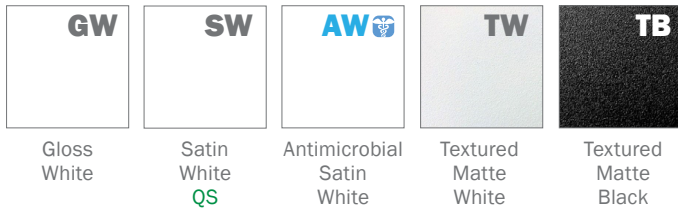

METALLIC POWDER COAT

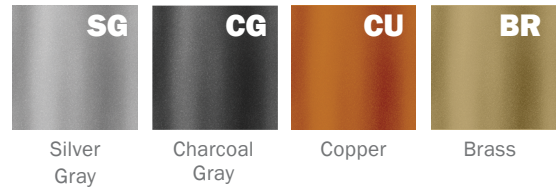

SATIN ANODIZED EFFECT POWDER COAT



GLOSS POWDER COAT (80-95% GLOSS)

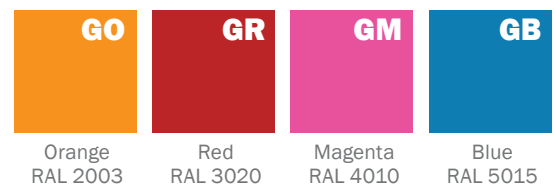

ALUMINUM*

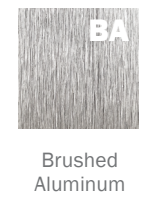

Contact ALW Quotes for sample paint finish swatches.

*Brushed aluminum finish available for an additional fee.

SPECIAL ORDER FINISHES*



RAL CLASSIC COLORS (80-95% GLOSS): RAL_ _ _ _

Most RAL Classic Colors are available for a minimum setup fee. On your specification submittal choose your RAL color by entering the 4-digit RAL code (Ex: RAL 3003). See www.alwusa.com/finishes



CUSTOM COLOR MATCH: CCM_ _ _ _

Custom powder coat color matching is available for a premium setup fee. Consult ALW for additional information.



CATALOG COLORS: CAT_ _ _ _

The complete range of powder coat colors from Tiger Drylac and TCI catalogs are available for a minimum setup fee. Consult ALW for a catalog color you would like to specify.

*An individual setup fee will apply to each unique Special Order Finish per purchase order. (ex: RAL 5023 and RAL 2008 are specified for multiple line items on a purchase order. 2x setup fees will apply)

*Printed or on-screen colors are only approximations - consult actual Color Chip Set before specifying)

CORD OPTIONS



Black
Order Code = **BK**

For all locations

Standard cord for Yoke suspensions.



White
Order Code = **WH**

For all locations



Clear Silver Braid
Order Code = **CB**

For dry and damp locations only



Cloth Cover
Order Code = **CC**

For dry and damp locations only.

For remote and deep canopy drivers only.

Specify cloth cord color in the suspension section of the part number. See page 7 for all cloth cord color options.



CLOTH CORD COLOR OPTIONS

FOR DAMP AND DRY LOCATIONS ONLY

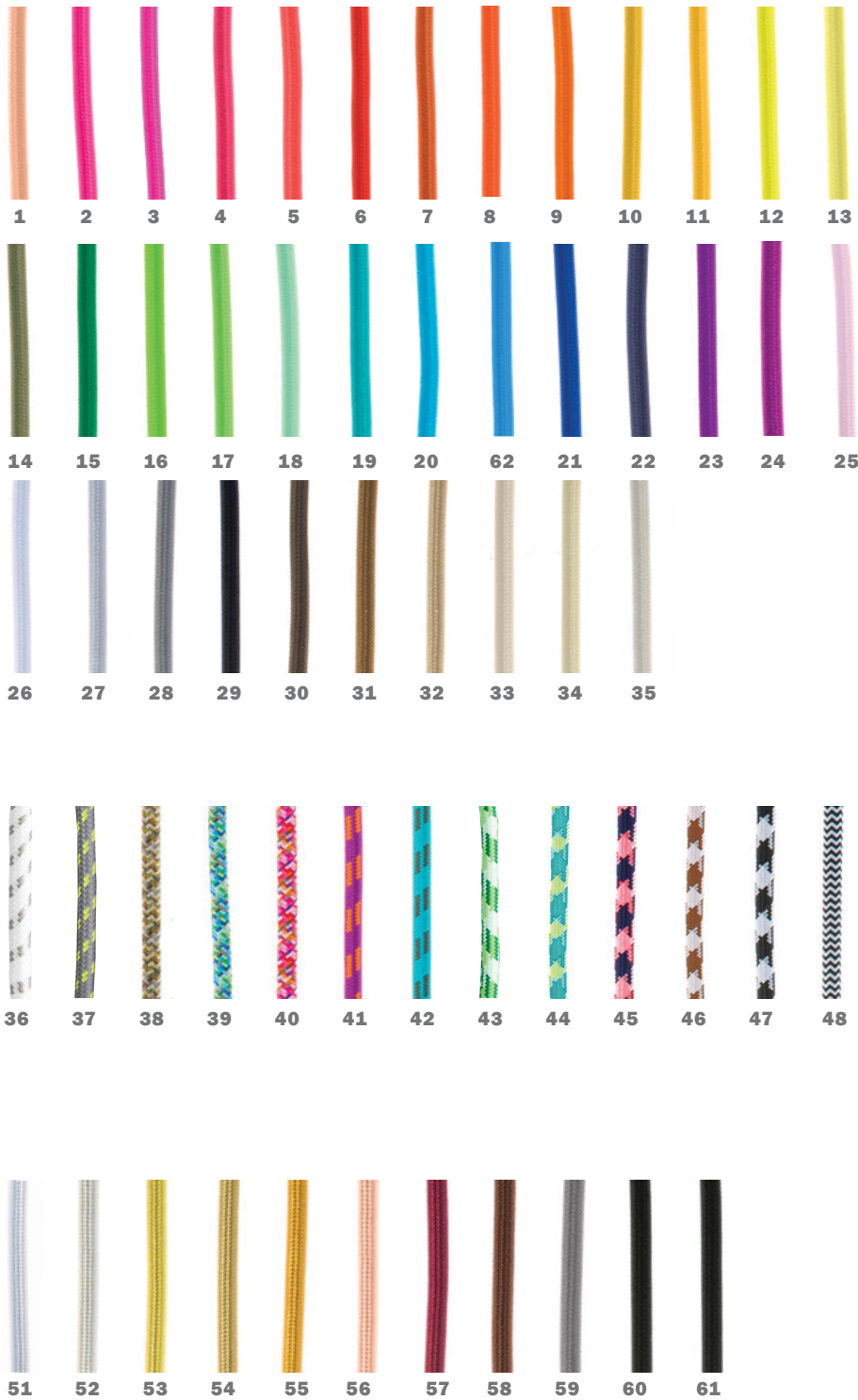

SOLID COLOR CLOTH CORDS

1. Peach
2. Pink
3. Neon Pink
4. Hot Pink
5. Neon Coral
6. Red
7. Adobe
8. Orange
9. Neon Orange
10. Goldenrod
11. Sunshine Yellow
12. Neon Yellow
13. Citrus Yellow
14. Olive Green
15. Kelly Green
16. Neon Green
17. Lime Green
18. Mint Green
19. Turquoise
20. Skyblue
62. Electric Blue
21. Cobalt Blue
22. Navy
23. Purple
24. Magenta
25. Blush
26. White
27. Silver
28. Gray
29. Black
30. Antique Brown
31. Chocolate Brown
32. Flax
33. Khaki
34. Sand
35. Ivory

PATTERNED CLOTH CORDS

36. White & Gray Dot
37. Gray & Citrus Yellow Dot
38. Neutral Tweed
39. Cool Tweed
40. Warm Tweed
41. Magenta & Orange Stripe
42. Turquoise & Brown Stripe
43. Green Argyle
44. Turq. & Yellow Houndstooth
45. Navy & Coral Houndstooth
46. Brown & Ivory Houndstooth
47. Black & White Houndstooth
48. Black & White Zigzag
49. Red & White Zigzag
50. Yellow & White Zigzag

METALLIC CLOTH CORDS

51. Pearl Metallic
52. Champagne Metallic
53. Yellow Gold Metallic
54. Brass Metallic
55. Copper Metallic
56. Copper Penny
57. Currant Metallic
58. Bronze Metallic
59. Gunmetal
60. Black Patent
61. Black Satin

SPECIFY **CLOTH CORD COLOR** IN SUSPENSION OPTIONS IN PRODUCT CODE. PRINTED OR ON-SCREEN COLORS ARE ONLY APPROXIMATIONS - CONSULT SAMPLE BEFORE SPECIFYING

SS021023



PERFORMANCE DETAILS

REFLECTOR OPTION	CRI	DELIVERED LUMENS ¹⁴	EFFICACY (LM/W)	WATTS(W)	CCT OPTIONS
15° 25° 35° 55° 80°	Ra = 90 ± 3	500	146	3.4	2700K 3000K 3500K 4000K
		1000	136	7.3	
		1500	130	11.5	
		2000	125	15.9	
		2500	121	20.4	
		3000	118	25.2	
		3500	115	30.3	
		4000	112	35.5	

*Based on 55deg reflector for all outputs, 4000K 90CRI.

*Refer to IES files for full performance data.

¹⁴Actual lumens measured in field may differ +/- 10%.

TM-30-18 DETAILS (90 CRI LAMPING)

CCT	CRI (Ra)	CRI (R9)	TM-30 Rf	TM-30 Rg
2700K	90.5	59.7	89.4	99.6
3000K	92.5	66.5	89.9	98.7
3500K	93.8	74.2	89.8	98.1
4000K	94.2	78.8	89.8	98.5



BIOS OVERVIEW



BIOS SkyBlue® technology is designed to provide the specific circadian stimulus required to improve overall sleep by **featuring a distinct peak in the 'skyblue' spectral power at 490nm**. Unlike traditional white LEDs, BIOS SkyBlue® makes it possible to achieve **high EML (Equivalent Melanopic Lux) and Melanopic/Photopic ratios** without harsh CCTs or high, glare-inducing light levels.

BIOS light engines are available for cylinder products with a **Dynamic** options for use with a variety of applications. Dynamic options include a dynamic board and Bio-Dimmer module to allow the user to dim-out the SkyBlue 490nm signal during night time hours.

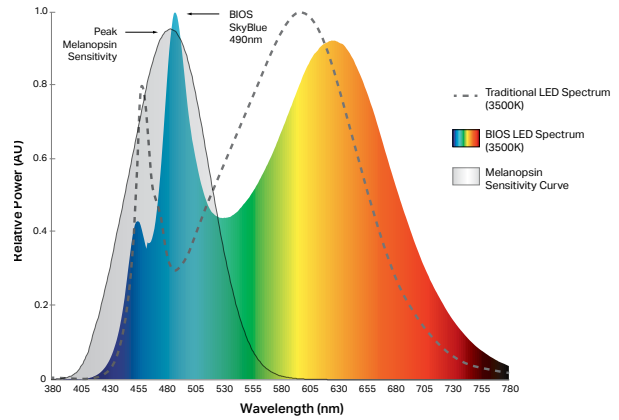

BIOS DYNAMIC + BIO-DIMMING (BIOSD)	
DESCRIPTION	Dynamic light engine with Bio-Dimming add the ability to fine-tune and dim-out the 490nm SkyBlue signal during night time hours or as desired.
TYPICAL APPLICATIONS	Environments occupied for a 24-hour period such as hospitals, security facilities, behavioral health facilities, factories, etc.
CONTROLS & DIMMING	Works with any standard dimming controls (0-10V, Dali, EcoSystem, Triac, DMX, Wireless, etc.). BIOS SkyBlue® LED can be dimmed-out using a standard control/dimmer.

BIOS LED LAMPING DETAILS (DYNAMIC)

DELIVERED LUMENS ¹⁵	WATTS (W)	EFFICACY (LM/W)
500	5.4	93
1000	11.1	90
1500	18.3	82
2000	23.8	77

BIOS LED PERFORMANCE DETAILS

CCT	CRI (R9) <i>Dynamic BIOS</i>	DAYTIME M/P RATIO ¹⁶ <i>Dynamic BIOS</i>	NIGHTTIME M/P RATIO ¹⁶ <i>Dynamic BIOS</i>	COI ¹⁷ <i>Dynamic BIOS</i>
3000K	83	0.73	0.45	3.3
3500K	83	0.84	0.50	3.1
4000K	83	0.95	0.55	3.1

¹⁵Delivered Lumens calculations are based on LM-79 test of BIOS 4000K, 2000lm output.

¹⁶Melanopic to photopic (M/P) ratios are used to help calculate equivalent melanopic lux (EML) values which is the metric used for circadian lighting in the WELL™ Building Standard.

¹⁷BIOS SkyBlue® meets the Cyanosis Observation Index (COI) requirements for visual assessment of cyanosis, providing a COI up to 3.3.



BIOS DYNAMIC + BIO-DIMMING DIMMING CONTROL CHARACTERISTICS

	DIMMER SETTING	BIOS SKYBLUE® LED	WHITE LED	LIGHT OUTPUT		
	100%* (Full On)	100%	100%	100%	Bio-Dimming	BIOS SkyBlue® maintained for maximum circadian impact. Light output remains relatively constant.
	99% - 51%	100% - 0%	100%	100% - 90%		
	50%	NO BIOS	100%	~90%	White LED Intensity Dimming	BIOS SkyBlue® removed to provide minimal circadian impact. White LED output dims linearly.
	49% - 0%	NO BIOS	100% - 0%	Linear Dimming 90% - 0%		

Dynamic BIOS Lumen Output vs. Driver Current

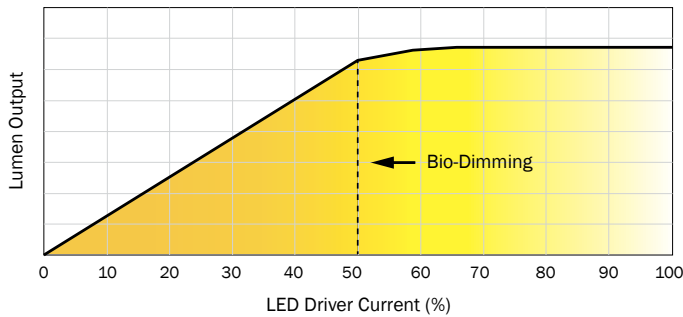

BIOS + Bio-Dimming™

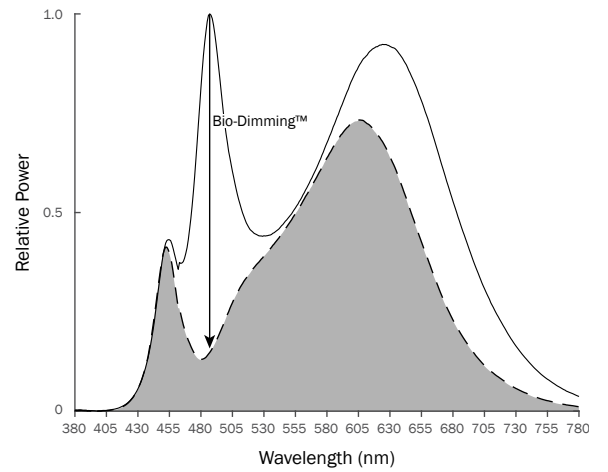

Dynamic BIOS SkyBlue vs. Driver Current

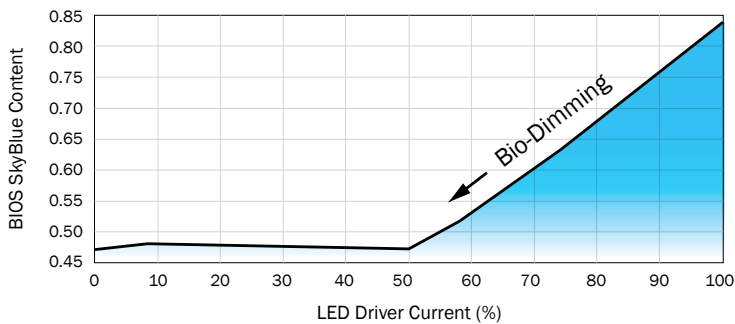



DRIVERS

PRODUCT CODE	DESCRIPTION
V00	0-10V dimming down to 0%
V01	0-10V dimming down to 1%
P01	Driver supports both TRIAC Forward Phase 2-Wire and ELV Reverse Phase 3-Wire dimming controls.
ELDVO	eldoLED, 0-10V dimming down to 0%
DALI	DALI flicker-free dimming down to 0%.
DMX	DMX flicker-free dimming down to 0%.
LDE1	ECOSYS1, (LDE1) Lutron Hi-Lume 1% EcoSystem LED driver with Soft-on, Fade-to-Black dimming technology
POEM	POE MOLEX. Molex CoreSync PoE LED Driver dimming down to 0.1%
POEI	IGOR PoE LED Driver. Contact ALW to assist with your project.
POEN	NuLEDS PoE LED Driver. Contact ALW to assist with your project.
POE	PoE Ready LED Driver. Contact ALW to assist with your project.

*Contact ALW for specific dimming level requests. ALW lighting fixtures are intended for use with a wide range of sensors, lighting controls, LED drivers, and building management systems. If there are specific components required for your application that aren't listed on this spec sheet, please contact ALW customer support today to specify a compatible solution of your choice.

DRIVER/LED LAMPING COMPATIBILITY				
	STD*	BIOS	CA TITLE 24 JA8/JA10 ¹⁸	IEEE P1789 & HD TV STUDIO ¹⁹
V00	●	●	●	
V01	●	●	●	
P01	●	●	●	
ELDVO	●	●	●	●
DALI	●	●	●	●
DMX	●	●	●	●
LDE1	●	●	●	●
POEM	PER REQUEST		●	●
POEI	PER REQUEST		●	●
POEN	PER REQUEST		●	●
POE	PER REQUEST		●	●

DRIVER LOCATION/DRIVER COMPATIBILITY			
	INTERNAL	DEEP CANOPY	REMOTE
V00	●	●	●
V01	●	●	●
P01	●	●	●
ELDVO		●	●
DALI		●	●
DMX		●	●
LDE1		●	●
POEM			●
POEI			●
POEN			●
POE			●

● - Indicates compatibility

*Standard lamping (STD) - 1000-6000LM

¹⁸Fixtures specified with 90CRI 2700K, 3000K, 3500K, and 4000K lamping with applicable LED drivers have the ability to conform to California Title 24 JA8 and JA10 Appendices.

¹⁹The following drivers conform to IEEE P1789 Flicker Standard: 'IEEE Recommended Practices for Modulating Current in High-Brightness LEDs for Mitigating Health Risks to Viewers'. These drivers may also be installed in HD TV Studio applications utilizing high frequency camera equipment.



SENSORS*

	PRODUCT CODE	DESCRIPTION	DRIVER LOCATION	SENSOR LOCATION
	N	None. Choose when sensors are not desired.	-	-
COOPER	WLNx	Fixture is built with 0/10V wiring to connect to Wavelinx Wireless sensors and power/relay packs (sensors and equipment not provided by ALW)	Internal Deep Canopy Remote	Remote
ENLIGHTED™	ENLGHt	Enlighted® remote connected lighting smart sensor - occ/daylight/networking (Enlighted Part: SU-5S-H-CL)	Remote	
LUTRON VIVE	FCJS	Lutron® Vive remote RF wireless fixture control (Lutron Part: FCJS-ECO or FCJS-010)	Remote	
	FCJS/S	Lutron® Vive remote RF wireless fixture control + daylight/occ sensor (Lutron Part: FCJS-ECO or FCJS-010, & FC-Sensor)	Remote	
MOLEX POE CORESYNC	MLX	Molex PoE sensors for use with Molex/PoE drivers. Customer will need to determine who to purchase PoE equipment from.	Remote	
NLIGHT WIRED®	NLT	Fixture is built to connect to nLight Wired remote components specified by agency. Contact ALW to review project details.	Remote	
NLIGHT WIRELESS®	NLTAIR	Fixture is built to connect to nLight Air (Wireless) remote components specified by agency. Contact ALW to review project details.	Remote	
VALUE SENSORS	OS/PH/HV	<i>Hubbell WASP High Voltage 0-10V remote surface mount occ/daylight sensor. 120/277/347VAC input (Hubbell Part: WSPDSMUNV) Automated Dimming Functionality: Connect fixture 0/10V wires to sensor in the field. Adjust occ/photocell settings as desired. On/Off or Manual Dimming Functionality: Turn photocell functionality OFF. Cap off 0/10V wires on sensor. Connect fixture 0/10V wires to wall dimmer in the field.</i>	Internal Deep Canopy Remote	

*All connected lighting sensors/systems must be programmed in the field by an electrical commissioner familiar with the system. Refer to the 'Sensor Compatibility' and 'Driver/Sensor Compatibility' charts to specify compatible sensors, LED lamping, and LED driver systems.

SENSOR COMPATIBILITY					
PRODUCT CODE		SENSOR TYPE	MAX MT HT	CA TITLE 24	STD*
COOPER WAVELINX	WLNx		15 ft	●	●
ENLIGHTED™	ENLGHt	OCCUPANCY/PHOTOCELL	40 ft	●	●
LUTRON VIVE	FCJS	WIRELESS CONTROL	12 ft	●	●
	FCJS/S	OCCUPANCY/PHOTOCELL	12 ft	●	●
MOLEX POE CORESYNC	MLX		16 ft	●	●
NLIGHT WIRED	NLT		15 ft	●	●
NLIGHT WIRELESS	NLTAIR		15 ft (average)	●	●
VALUE SENSORS	OS/PH/HV	OCCUPANCY/PHOTOCELL	45 ft	●	●

● - Indicates compatibility ■ - On/off sensor functionality only

*Standard lamping (STD) - 500 - 6000LM

DRIVER/SENSOR COMPATIBILITY									
	WLNx	ENLGHt	MLX	FCJS	FCJS/S	NLT	NLTAIR	OS/PH/HV	NO SENSOR
V00	●	●		●	●			■	●
V01	●	●		●	●			■	●
P01								■	●
ELDVO						●	●	▲	●
DALI								■	●
DMX								■	●
LDE1				●	●				●
POEM			●						●
POEI	Sensor types will depend on the PoE system configuration. Contact ALW for details.								
POEN	Sensor types will depend on the PoE system configuration. Contact ALW for details.								
POE	Sensor types will depend on the PoE system configuration. Contact ALW for details.								

● - Indicates compatibility

▲ - Fixture can have automated dimming via sensor OR on/off functionality and manual dimming

■ - On/off sensor functionality only



PHOTOMETRICS CORE 4

BEAM ANGLE (°)	POLAR PLOT (CD)	MTG HEIGHT (FT)	LIGHT LEVEL (FC)	BEAM DIAMETER (FT)	SPACING CRITERION (SC) ²⁰ (0° - 180°) (90° - 270°)	MAX INTENSITY (CD)
15°		6	358.9	1.8	.28 .28	12920
		8	201.9	2.3		
		10	129.2	2.9		
		12	89.7	3.5		
		14	65.9	4.1		
		16	50.5	4.7		
25°		6	299.8	3.0	.47 .47	10793
		8	168.6	4.0		
		10	107.9	5.0		
		12	75.0	6.0		
		14	55.1	7.0		
		16	42.2	8.0		
35°		6	197.0	3.9	.58 .58	7094
		8	110.8	5.2		
		10	70.9	6.5		
		12	49.3	7.8		
		14	36.2	9.1		
		16	27.7	10.5		
55°		6	101.6	6.8	.94 .94	3670
		8	57.2	9.1		
		10	36.6	11.3		
		12	25.4	13.6		
		14	18.7	15.9		
		16	14.3	18.1		
80°		6	61.0	10.0	1.26 1.26	2195
		8	34.3	13.4		
		10	21.9	16.7		
		12	15.2	20.1		
		14	11.2	23.4		
		16	8.6	26.7		

*Photometric calculations based on 3000lm 4000K 90CRI fixture combination. Actual results may vary in the field.

For footcandle and output multipliers refer to the [ALW IES File Multipliers Chart](#).

²⁰Spacing criterion refers to maximum distance luminaires can be spaced to provide uniform illumination on the working plane or surface.

Luminaire spacing = Spacing Criterion (SC) x Mounting Height (MH) (ex. 1.14 (SC) x 10' (MH) = 11.4' Luminaire Spacing).



ADDITIONAL OPTIONS & SPECIFICATIONS

LED PERFORMANCE

> 55,000 hours at 80% lumen maintenance, LM80 / TM-21

COLOR CONSISTENCY

3 SDCM; 90 CRI typical

HOUSING

Extruded aluminum with galvanized steel hardware

SAFETY & REGULATORY

Can be used to comply with **Title 24 JA8 and JA10** requirements. Contact ALW customer support today and we can help you with your project requirements.

UL Listed (U.S. & Canada). Suitable for dry or damp locations. Conforms to UL 1598, 2108, 8750 Certified to CSA std. CSA C22.2# 9 & #250.0

OPERATING TEMPERATURE

Luminaire should be installed and operated ONLY in dry or damp environments where the ambient temperature ranges from -4 °F to 104 °F (-20 °C to 40 °C). Luminaire operation in environments outside the listed temperature range voids the warranty AND may damage the product or adversely impact lamp life, lumen output and color consistency.

WOOD VENEER

Most ALW fixture configurations are available with **real wood veneer** as a custom request. Contact **ALW customer support** so we can help you with your custom wood veneer request.

CONTROLS, SENSORS, & LED DRIVER

ALW lighting fixtures are intended for use with a wide range of sensors, lighting controls, LED drivers, and building management systems. Our component portfolio is continually expanding to adopt to the latest technologies and specification needs. We currently support integration with Lutron, Enlighted, EldoLED, nLight, Osram, Philips, and more. If there's a component or system needed that you don't see on the spec sheet please contact ALW customer support today so we can review your requirements.

WARRANTY

LIMITED WARRANTY. Visit alwusa.com/warranty for more information.

WEIGHT

CORE 4			
PENDANT	SURFACE MOUNT	SCONCE	YOKE
7 lbs/ 3.2 kg	7 lbs/ 3.2 kg	7 lbs/ 3.2 kg	7 lbs/ 3.2 kg