



CORE/WL 3

ROUND, WET LOCATION, DIRECT ILLUMINATION



SPECIFICATIONS

PROFILE	Round
SIZE	3.5" diameter, 8.1" or 5.0" shell height
LED OUTPUT	700lm - 2,000lm
CCT/CRI	2700K/3000K/3500K/4000K • 83 CRI or 98 CRI
DIMMING/ DRIVER	Internal, Canopy, and Remote Driver: 0-10V, Phase, DALI, DMX, eldoLED, Lutron®. Dimming to 0% for select models.
POWER	5.6W to 19.5W per fixture
INPUT	100VAC to 277VAC Phase dimmable versions are 120VAC only
OPTICS	10° - 80° distribution spun aluminum reflectors. Field replaceable without tools.
FINISHES	Powder coat - TGIC polyester for exterior and interior use
MATERIAL	Extruded aluminum with stainless steel hardware
ENVIRONMENT	Wet location, IP66 rated LED module

WELL

For UGR values and recommended options that contribute to meeting the WELL Building Standard™ see [WELL addendum](#).

*Safety and Performance information available on last page. Output and other specifications available on page 6.

DISTRIBUTIONS & PROFILES

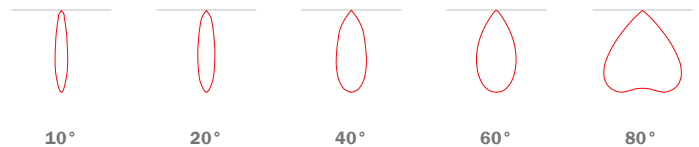

CORE/WL 3
PENDANT



CORE/WL 3
SURFACE MOUNT



CORE/WL 3
SCONCE



CORE/WL 3
YOKE

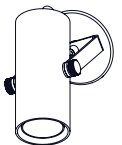

CORE/WL 3
PENDANT

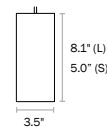

CORE/WL 3
SURFACE MOUNT

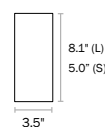

CORE/WL 3
SCONCE

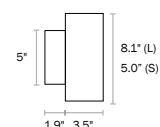

CORE/WL 3
YOKE

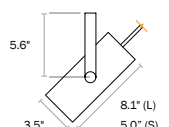

Not to scale. Dimensions are nominal. Consult factory for CAD drawing





PRODUCT SUBMITTAL QUICK WORKSHEET

-	-	-	-	-	-	-	-	-	-	-	-	-
1	2	3	4	5	6	7	8	9	10	11	12	13

EXAMPLE: CRP3/WL – 10982740HL – RV10 – L – BABK/12 – AC – EMB

1. MODEL (CHOOSE 1)	2. OUTPUT (CHOOSE 1)	3. CRI (CHOOSE 1)	4. CCT (CHOOSE 1)
<input type="checkbox"/> CRP3/WL Pendant	<input type="checkbox"/> 07 700lm	<input type="checkbox"/> 83 83	<input type="checkbox"/> 27 2700K
<input type="checkbox"/> CRM3/WL Surface Mount	<input type="checkbox"/> 10 950lm	<input type="checkbox"/> 98 98	<input type="checkbox"/> 30 3000K
<input type="checkbox"/> CRS3/WL Sconce	<input type="checkbox"/> 13 1300lm		<input type="checkbox"/> 35 3500K
<input type="checkbox"/> CRY3/WL Yoke	<input type="checkbox"/> 20¹ 2000lm		<input type="checkbox"/> 40 4000K

¹Available for 83CRI only

5. REFLECTOR* (CHOOSE 1)	6. OPTICAL ACCESSORY (CHOOSE 1)	7. DRIVER LOCATION* (CHOOSE 1)	8. DIMMING* (CHOOSE 1)
<input type="checkbox"/> 10² 10° (0.3 S/MH)	<input type="checkbox"/> NN None	<input type="checkbox"/> N^{5,6} Internal	<input type="checkbox"/> V10 (0-10V, dim to 10%)
<input type="checkbox"/> 20 20° (0.4 S/MH)	<input type="checkbox"/> HL³ Honeycomb Louver	<input type="checkbox"/> R Remote	<input type="checkbox"/> P10 (Phase, dim to 10%)
<input type="checkbox"/> 40 40° (0.7 S/MH)	<input type="checkbox"/> DF Diffusion Lens	<input type="checkbox"/> D⁷ Deep Canopy	<input type="checkbox"/> ELDVO (eldoLED, 0-10V, dim to 0%)
<input type="checkbox"/> 60 60° (0.8 S/MH)	<input type="checkbox"/> LS Linear Spread Lens (60° x 1°)		<input type="checkbox"/> LDE1⁸ (Lutron ECOSYS1, 0-10V, dim to 1%)
<input type="checkbox"/> 80 80° (1.3 S/MH)	<input type="checkbox"/> WW Wall Wash Lens (shifts beam 20° from vertical)		<input type="checkbox"/> LTEA⁹ (Lutron HI-Lume, Phase dim, 2-wire to 1%)

*Beam angles noted above are nominal.

²Available for 1300lm 83CRI and lower or 950lm 98CRI and lower.

³Not available for UP sconce style.

⁴Available for sconce only.

*See 'Dimming/driver location compatibility on page 7 to ensure correct dimming specification.

⁵Sconce only.

⁶Internal driver located in arm on sconces.

⁷Not available for sconces.

⁸See 'Driver' and 'dimming/driver compatibility' charts for dimming compatibility.

⁹Premium drivers available for remote driver location only.

9. SHELL HEIGHT* (CHOOSE 1)	10. SHELL COLOR* (CHOOSE 1)	11. SUSPENSION* (CHOOSE 1)	12. SUSPENSION OPTIONS (OPTIONAL CHOOSE 1)
<input type="checkbox"/> L 8.1" Shell	FINISHES**	PENDANT OPTIONS	PENDANT OPTIONS
<input type="checkbox"/> S^{9,10} 5.0" Shell	<input type="checkbox"/> SG <input type="checkbox"/> Silver Gray	<input type="checkbox"/> BK¹¹ Black Cord	<input type="checkbox"/> AC Aircraft Cable
	<input type="checkbox"/> SW <input type="checkbox"/> Satin White	<input type="checkbox"/> RS##¹² Rigid Stem	<input type="checkbox"/> SB¹³ Seismic Bracing
	<input type="checkbox"/> SB <input type="checkbox"/> Satin Black	<input type="checkbox"/> SS##¹² Swivel Stem	SCONCE OPTIONS
	<input type="checkbox"/> --- Specify Finish Code (Ex: OB = Oil-Rubbed Bronze)	YOKE OPTIONS	<input type="checkbox"/> UP¹⁴ Uplight

*See page 3 for shell dimension drawings.

⁹Available for remote and deep canopy driver locations.

¹⁰Internal driver location available for sconces only.

SPECIAL ORDER FINISHES**

RAL_____ Specify RAL Classic Color (Ex: RAL 3003) -

CAT_____ Specify Catalog Colors

CCM_____ Specify Custom Color Match

*See page 5 for finish chart.

^{*}Manually type the finish code into the parametric code above.

^{*}Selection not required for surface mount and sconce.

¹¹Standard cord length 8ft. For longer cords, type desired length after cord style in product code above (i.e BK/8 = Black Cord + 8ft cord length)

¹²Type desired stem length (4" -100") into product code above.

¹³Seismic bracing only available for Rigid Stem suspensions.

¹⁴Includes reflector cover.

13. EMERGENCY OPTIONS* (OPTIONAL)

EMB¹⁵ Emergency Battery

*Emergency options only available with 0-10V driver options.

Third party inverter system recommended for other driver options. Refer to [ALW EM Solution Catalog](#) for all compatibility exceptions.

¹⁵Available for remote driver only.

SS071222



DIMENSIONS AND MOUNTING

SHELL HEIGHT L

**CORE/WL 3
PENDANT**

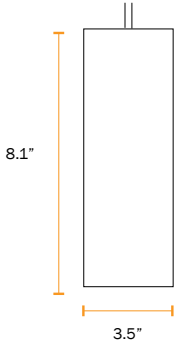

**CORE/WL 3
SURFACE**

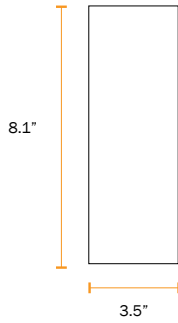

**CORE/WL 3
SCONCE**

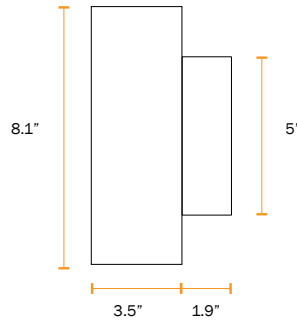

**CORE/WL 3
YOKE**

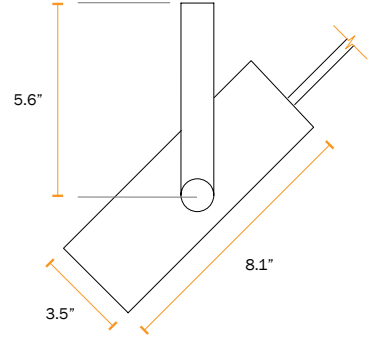

SHELL HEIGHT S

**CORE/WL 3
PENDANT**

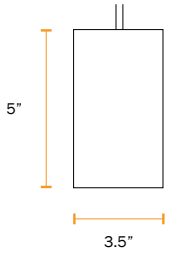

**CORE/WL 3
SURFACE**

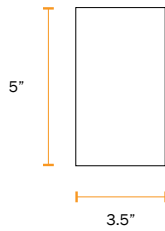

**CORE/WL 3
SCONCE**

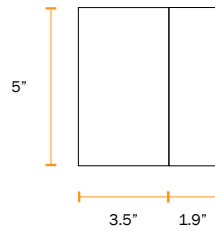

**CORE/WL 3
YOKE**

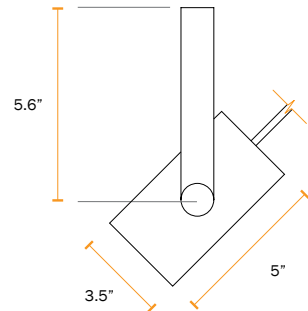

REMOTE DRIVER

STANDARD SHALLOW CANOPY

PENDANT ONLY

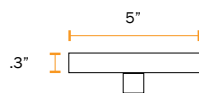
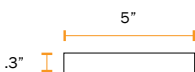

DEEP CANOPY MOUNTED DRIVER^{16,17}

DEEP CANOPY FOR CANOPY MOUNTED LED DRIVERS

PENDANT ONLY

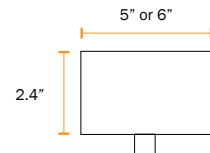
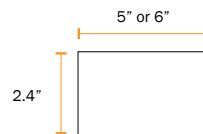

Not to scale. Dimensions are nominal. Consult factory for CAD drawings
All canopies fit standard 3.5" and 4" round and octagonal junction boxes.

¹⁶Deep canopy diameter depends on LED driver size

¹⁷Dual output emergency battery fixtures may require 7" canopy

SS071222



DIMENSIONS AND MOUNTING

YOKE STANDARD CANOPY

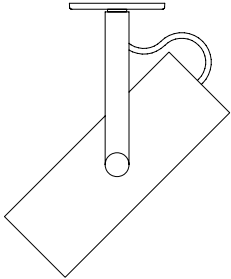

YOKE RIGID STEM

Includes 10° hang straight

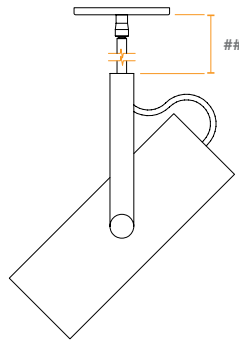

YOKE SWIVEL STEM

360° rotation x 90° tilt swivel

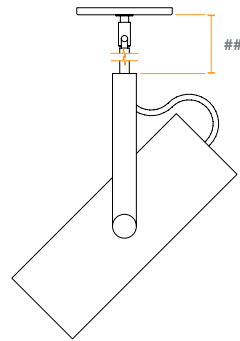

= length in inches from bottom of canopy to top of yoke

PENDANT SUSPENSION OPTIONS

SWIVEL STEM

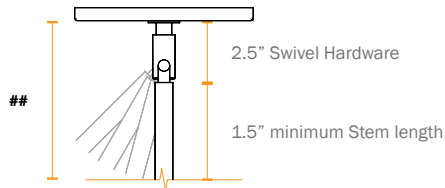

Order Code = **SS##**

= length in inches from bottom of canopy to top of fixture. Includes the swivel hardware. Minimum length for swivel hardware + stem is 4". Total length (##) for swivel hardware alone is 2.5".

360° rotation x 90° tilt swivel

RIGID STEM

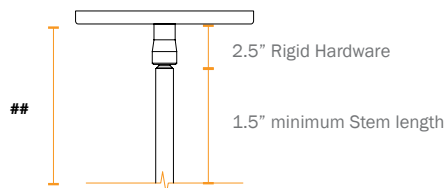

Order Code = **RS##**

= length in inches from bottom of canopy to top of fixture. Includes the rigid hardware. Minimum length for rigid hardware + stem is 4". Total length (##) for rigid hardware alone is 2.5".

Includes 10° hang straight

AIRCRAFT CABLE

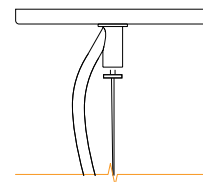

Order Code = **AC**

Standard cable length = 6'

Cable length is field adjustable



FINISHES

BASIC POWDER COAT

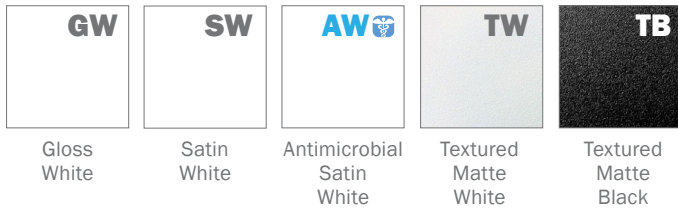

METALLIC POWDER COAT

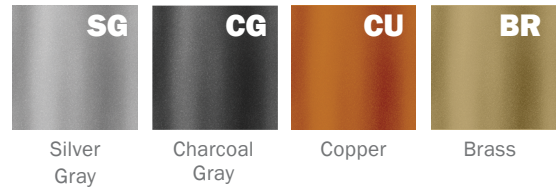

SATIN ANODIZED EFFECT POWDER COAT



GLOSS POWDER COAT (80-95% GLOSS)

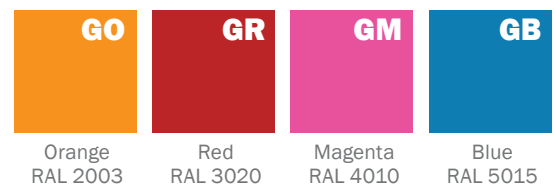

Contact ALW Quotes for sample paint finish swatches.

SPECIAL ORDER FINISHES*



RAL CLASSIC COLORS (80-95% GLOSS): RAL_ _ _ _

Most RAL Classic Colors are available for a minimum setup fee. On your specification submittal choose your RAL color by entering the 4-digit RAL code (Ex: RAL 3003). See www.alwusa.com/finishes



CUSTOM COLOR MATCH: CCM_ _ _ _

Custom powder coat color matching is available for a premium setup fee. Consult ALW for additional information.



CATALOG COLORS: CAT_ _ _ _

The complete range of powder coat colors from Tiger Drylac and TCI catalogs are available for a minimum setup fee. Consult ALW for a catalog color you would like to specify.

*An individual setup fee will apply to each unique Special Order Finish per purchase order. (ex: RAL 5023 and RAL 2008 are specified for multiple line items on a purchase order. 2x setup fees will apply)

*Printed or on-screen colors are only approximations - consult actual Color Chip Set before specifying)

CORD OPTIONS



Black
Order Code = **BK**

For all locations



PERFORMANCE DETAILS

REFLECTOR OPTION ¹⁸	CRI	OUTPUT OPTIONS	DELIVERED LUMENS ¹⁹	EFFICACY (LM/W)	SYSTEM WATTS(W)	CCT OPTIONS
10° 20° 40° 60° 80°	Ra = 83 ± 3	700	643	115	5.6	2700K 3000K 3500K 4000K
		950	873	106	8.2	
		1300	1196	102	11.7	
		2000	1839	94	19.5	
	Ra = 98 ± 3	700	643	86.9	7.4	
		950	873	80.1	10.9	
		1300	1196	76.7	15.6	

^{*}Based on 40° reflector for all outputs.

^{*}Refer to IES files for full performance data.

¹⁸10° Reflector only available for 83CRI 1300lm and lower and 98CRI 950lm and lower.

¹⁹Actual lumens measured in field may differ +/- 10%.



DRIVERS

PRODUCT CODE	DESCRIPTION
V10	0-10V dimming down to 10%
P10	ELV/TRIAC Phase dimming down to 10%
ELDV0	eldoLED, 0-10V dimming down to 0%
DALI	DALI flicker-free dimming down to 0%.
DMX	DMX flicker-free dimming down to 0%.
LDE1	ECOSYS1, (LDE1) Lutron Hi-lume 1% EcoSystem LED driver with Soft-on, Fade-to-Black dimming technology
LTEA	LTEA. Lutron Hi-lume 1% 2-wire TRIAC dimming (120V forward-phase only)

*Contact ALW for specific dimming level requests. ALW lighting fixtures are intended for use with a wide range of sensors, lighting controls, LED drivers, and building management systems. If there are specific components required for your application that aren't listed on this spec sheet, please contact ALW customer support today to specify a compatible solution of your choice.

DRIVER/LED LAMPING COMPATIBILITY			
	STD*	CA TITLE 24 JA8/JA10 ²⁰	IEEE P1789 & HD TV STUDIO ²¹
V10	●		
P10	●		
ELDV0	●	●	●
DALI	●	●	●
DMX	●	●	●
LDE1	●	●	●
LTEA	●	●	

● - Indicates compatibility

*Standard lamping (STD) - 700-2000LM

²⁰Fixtures specified with 83CRI, 98CRI, 2700K, 3000K, 3500K, and 4000K lamping with applicable LED drivers have the ability to conform to California Title 24 JA8 and JA10 Appendices.

²¹The following drivers conform to IEEE P1789 Flicker Standard: 'IEEE Recommended Practices for Modulating Current in High-Brightness LEDs for Mitigating Health Risks to Viewers'. These drivers may also be installed in HD TV Studio applications utilizing high frequency camera equipment.

DRIVER LOCATION/DRIVER COMPATIBILITY			
	INTERNAL*	DEEP CANOPY	REMOTE
V10	●	●	●
P10	●	●	●
ELDV0		●	●
DALI		●	●
DMX		●	●
LDE1		●	●
LTEA		●	●

*Internal driver only available for sconces. Driver located in sconce arm.



PHOTOMETRICS CORE/WL

BEAM ANGLE (°)	POLAR PLOT (CD)	MTG HEIGHT (FT)	LIGHT LEVEL (FC)	BEAM DIAMETER (FT)	SPACING CRITERION (SC) ²² (0° - 180°) (90° - 270°)	MAX INTENSITY (CD)	BUG RATING
10°		6	315.8	1.8	.30 .30	11370	B2-U0-G0
		8	177.7	2.4			
		10	113.7	3.0			
		12	79.0	3.5			
		14	58.0	4.1			
		16	44.4	4.7			
20°		6	173.0	2.6	.40 .40	6228	B2-U0-G0
		8	97.3	3.4			
		10	62.3	4.3			
		12	43.3	5.1			
		14	31.8	6.0			
		16	24.3	6.8			
40°		6	87.6	4.5	.65 .65	3154	B2-U1-G0
		8	49.3	5.9			
		10	31.5	7.4			
		12	21.9	8.9			
		14	16.1	10.4			
		16	12.3	11.9			
60°		6	40.7	5.9	.80 .80	1465	B1-U1-G1
		8	22.9	7.9			
		10	14.7	9.8			
		12	10.2	11.8			
		14	7.5	13.7			
		16	5.7	15.7			
80°		6	34.4	10.2	1.31 1.31	1355	B2-U0-G0
		8	19.3	13.6			
		10	12.4	17.0			
		12	8.6	20.4			
		14	6.3	23.8			
		16	4.8	27.2			

*Photometric calculations based on 2000lm 2700K-4000K 83CRI-98CRI fixture combination. Actual results may vary in the field.

For footcandle and output multipliers refer to the [ALW IES File Multipliers Chart](#).

²²Spacing criterion refers to maximum distance luminaires can be spaced to provide uniform illumination on the working plane or surface.
Luminaire spacing = Spacing Criterion (SC) x Mounting Height (MH) (ex. 1.14 (SC) x 10' (MH) = 11.4' Luminaire Spacing).



ADDITIONAL OPTIONS & SPECIFICATIONS

LED PERFORMANCE

> 55,000 hours at 70% lumen maintenance, LM80 / TM-21

COLOR CONSISTENCY

1x2 SDCM (MacAdam) along BBL, CCT +/- 40K to 70K, Duv +/- .001

HOUSING

Extruded aluminum with stainless steel hardware

SAFETY & REGULATORY

Can be used to comply with **Title 24 JA8 and JA10** requirements. Contact ALW customer support today and we can help you with your project requirements.

ETL Listed (U.S. & Canada). Suitable for wet locations.
Conforms to UL 1598, 2108, 8750
Certified to CSA std. CSA C22.2# 9 & #250.0

OPERATING TEMPERATURE

Luminaire should be installed and operated **ONLY** in environments where the ambient temperature ranges from -4 °F to 104 °F (-20 °C to 40 °C). Luminaire operation in environments outside the listed temperature range voids the warranty **AND** may damage the product or adversely impact lamp life, lumen output and color consistency.

CONTROLS & LED DRIVER

ALW lighting fixtures are intended for use with a wide range of sensors, lighting controls, LED drivers, and building management systems. Our component portfolio is continually expanding to adopt to the latest technologies and specification needs. If there's a component or system needed that you don't see on the spec sheet please contact ALW customer support today so we can review your requirements.

WARRANTY

LIMITED WARRANTY. Visit alwusa.com/warranty for more information.

WEIGHT

CORE/WL 3			
PENDANT	SURFACE MOUNT	SCONCE	YOKE
4.5 lbs/ 2.1 kg	4.5 lbs/ 2.1 kg	4.5 lbs/ 1.1 kg	2.75 lbs/ 1.25 kg