

THE PICCOLO FIXTURE

The Piccolo is a special micro fixture that stands just 0.23 in. (5.91 mm) high and 0.2 in. (5 mm) wide. The Piccolo uses a flat milky lens to create pinpoint lines of light in tight spaces such as custom millwork. It is sold in custom sizes ranging from 2.04 in. (51.7 mm) to 6 ft. 5.75 in. (1974.7 mm) long in increments of 1.52 in. (38.46 mm). The Piccolo features a special IP20 micro RibbonLyte that provides 90+ CRI in six available CCTs ranging from 2200K to 4000K.

- 3.0 W/ft (9.8 W/m)
- 0.2 in. (5 mm) wide by 0.23 in. (5.91 mm) high
- Fixture includes secure VHB tape backing
- Smallest fixture at 2.04 in. (51.7 mm) including end caps
- Sold in 1.52 in. (38.46 mm) increments up to 6 ft 5.75 in. (1974.7 mm)
- 110-degree beam angle
- Flat milky lens
- 55 LEDs/ft (182 LEDs/m)
- 90+ CRI
- IP20 rating for indoor use



HOUSING FINISHES

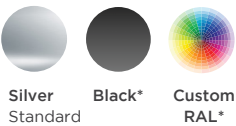

* Consult factory. Additional fee and MOQ apply.

AVAILABLE LENS FINISHES

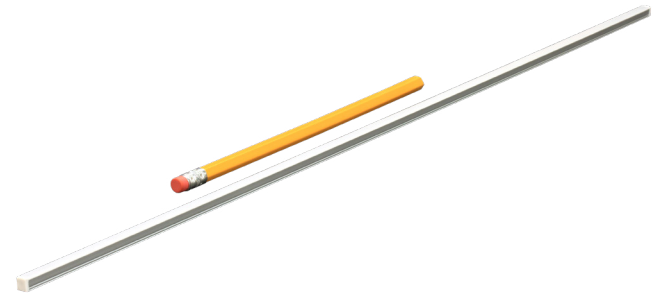

AVAILABLE COLOR TEMPERATURES



DIMENSIONS

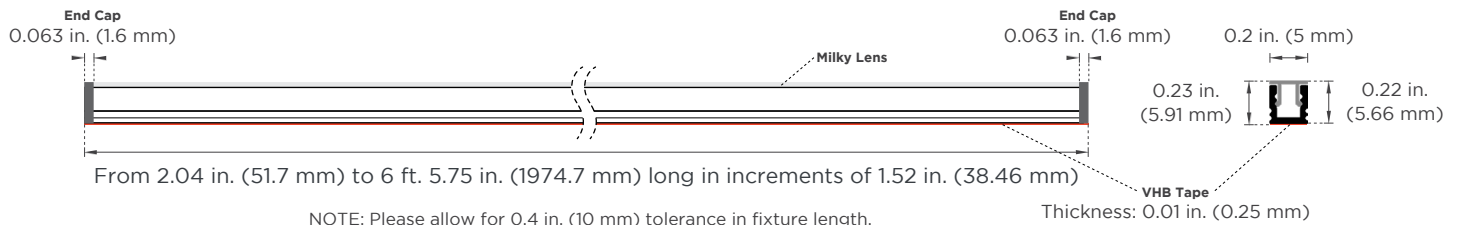

ORDERING GUIDE

Model	Wattage	Color Temp.	LENS	HOUSING COLOR
PIC	3.0		M	
PIC - The Piccolo Fixture	3.0 - 3.0 W/ft (9.8 W/m)	22 - 2200K 30 - 3000K 24 - 2400K 35 - 3500K 27 - 2700K 40 - 4000K	M - Milky Lens	SV - Silver (default) BK - Black Consult factory for custom colors. Additional fee and MOQ apply.

NOTE: The Piccolo is sold as a complete custom fixture. Cutting a Piccolo fixture in the field will void the warranty.



SPECIFICATIONS

Beam Angle	110°
Lens Type	Milky Lens
Length	Smallest fixture at 2.04 in. (51.7 mm) including end caps. Sold in 1.52 in. (38.46 mm) increments up to 6 ft 5.75 in. (1974.7 mm). Please allow for 0.4 in. (10 mm) tolerance in fixture length. (See dimension drawing at bottom of page 1 for reference.)
Operating Voltage	24V
Dimming	MLV / 0-10 Volt / ELV / DALI / DMX
Operating Temperature	-40° F to 158° F (-40° C to 70° C)
Colors	2200K, 2400K, 2700K, 3000K, 3500K, 4000K
CRI	90+ CRI
Power Feed Option	End feed
Lamp Life	L70 at 50,000 Hours
MacAdam Ellipses (SDCM)	2-Step Binning (For Static White LEDs only)
Certifications	UL Listed UL 2108 Issued: 2004/02/27 Ed: 1 Rev: 2014/02/24 Low Voltage Lighting Systems CSA C22.2#9.0 Issued: 1996/06/01 Ed: 1 (R2011) General Requirements for Luminaries; with Gen. Inst. 1: 1997, Gen Inst. 2: 1998. ROHS compliant

RIBBONLYTE SPECIFICATIONS

Cuttible Length	LED Pitch	Color Temperature	lm/W without Lens	Delivered Lumens with Milky Lens	Max Length
1.52 in. (38.46 mm)	55 LEDs/ft (182 LEDs/m)	2200K	72	136 lm/ft (447 lm/m)	6 ft 7 in. (2 m)
		2400K	77	146 m/ft (477 lm/m)	
		2700K	81	153 lm/ft (501 lm/m)	
		3000K	84	159 lm/ft (522 lm/m)	
		3500K	87	164 lm/ft (537 lm/m)	
		4000K	92	175 lm/ft (572 lm/m)	

NOTE: The Piccolo is sold as a complete custom fixture. Cutting a Piccolo fixture in the field will void the warranty.

24V DIMENSIONS	Top View	Side View	Dimensions
IP20	 <p>CUTTIBLE EVERY: 1.52 in (38.5 mm)</p>		<p>Width 0.2 in (3 mm) Max Length 6 ft 7 in. (2 m) Height 0.06 in (1.45 mm)</p>

Acolyte does not warrant or represent that the information is free from errors or omission. The information may change without notice and Acolyte is not in any way liable for the accuracy of any information printed and stored or in any way interpreted or used.

AVAILABLE DRIVERS / CONTROLLERS AND DIMMING OPTIONS / WIRE GAUGE CHART

NON-DIMMING ELECTRONIC DRIVERS

ELV & MLV DRIVERS



**30W, 60W, 96W
Non-Dimming Electronic
Class 2 Drivers**

- Part No.:
- DRVW2430 (30 Watt)
 - DRVW2460 (60 Watt)
 - DRVW2496 (96 Watt)

Output Voltage: 24 V
Voltage Range: 120-277 VAC
IP Rating: Dry or Damp
UL Listed



**240W, 320W
Non-Dimming
Electronic Drivers**

- Part No.:
- DRVW24240 (240 Watt)
 - DRVW24320 (320 Watt)

Output Voltage: 24 V
Voltage Range: 90-305 VAC
IP Rating: Dry or Damp
UL Recognized



**60W, 96W, 150W, 300W
ELV/MLV Dimmable Drivers**

- Part No.:
- DRVW2460ELVMLV (60 Watt)
 - DRVW2496ELVMLV (96 Watt)
 - DRVW24150ELVMLV (150 Watt)
 - DRVW24300ELVMLV (300 Watt)

Line Voltage Dimmable Drivers
Output Voltage: 24 V
Voltage Range: 100-277 VAC
IP Rating: IP67
Dimmable
UL, CE, and CSA Listed

0-10V DRIVERS



0-10V Dimmable Waterproof Drivers

96W Part No.: DRVW249610P
288W Part No.: DRVW2428810P
Output Voltage: 24 V (+/- 0.5V)
Voltage Range: 100-277 VAC
Environmental Rating: UL Wet Location
UL Listed

DRIVER AND RIBBONLYTE AT FULL LOAD

Wattages Wire Gauge	30		60		96		150		200		240		300		320	
	Feet	Meters	Feet	Meters	Feet	Meters	Feet	Meters	Feet	Meters	Feet	Meters	Feet	Meters	Feet	Meters
24 AWG / 0.25 mm ²	14	4.27	9	2.74	5.5	1.68	3.75	1.14	2.75	0.84	2.25	0.69	1.75	0.53	1.75	0.53
22 AWG / 0.34 mm ²	22	6.71	14	4.27	9	2.74	5.75	1.75	4.5	1.37	3.5	1.07	2.75	0.84	2.75	0.84
20 AWG / 0.5 mm ²	35	10.67	23	7.01	14	4.27	9	2.74	7	2.13	5.75	1.75	4.5	1.37	4.25	1.30
18 AWG / 0.75 mm ²	56	17.07	37	11.28	23	7.01	15	4.57	11	3.35	9	2.74	7.5	2.29	7	2.13
16 AWG / 1.5 mm ²	90	27.44	60	18.29	37	11.28	24	7.32	18	5.49	15	4.57	12	3.66	11	3.35
14 AWG / 2.5 mm ²	142	43.29	95	28.96	59	17.99	38	11.59	28	8.54	23	7.01	19	5.79	17	5.18
12 AWG / 4 mm ²	226	68.90	151	46.04	94	28.66	60	18.29	45	13.72	37	11.28	30	9.15	28	8.54
10 AWG / 6 mm ²	360	109.76	240	73.17	150	45.73	96	29.27	72	21.95	60	18.29	48	14.63	45	13.72
8 AWG / 10 mm ²	574	175.00	381	116.16	239	72.87	153	46.65	115	35.06	95	28.96	76	23.17	71	21.65

WIRING DIAGRAM

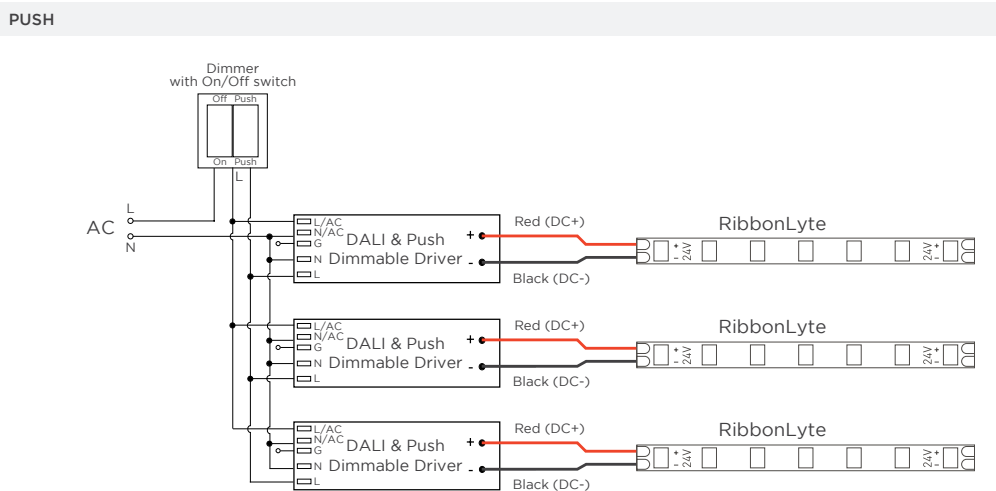
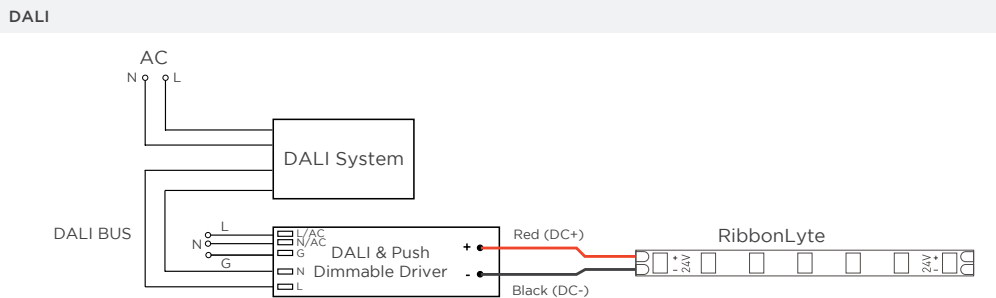
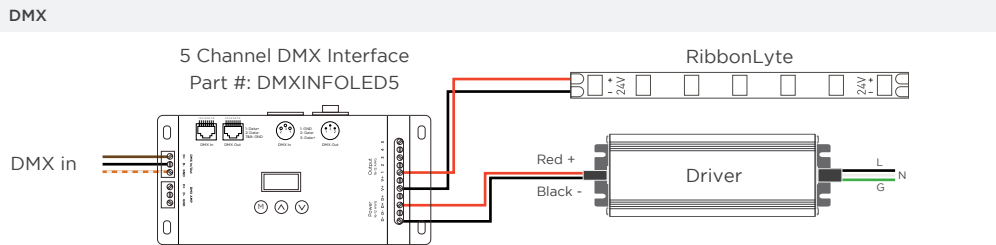
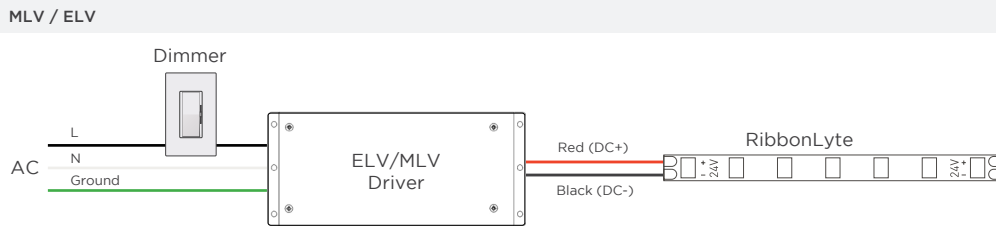
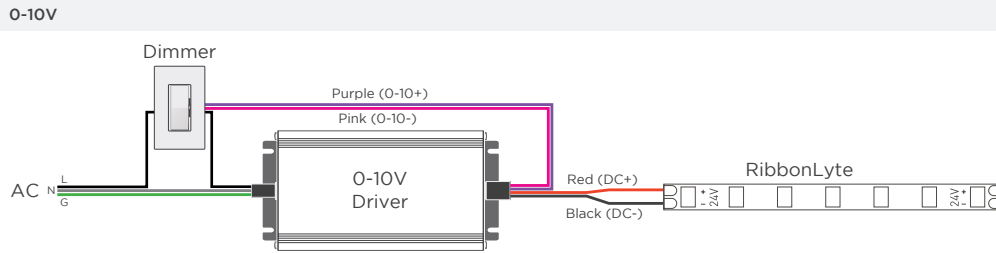

WIRE COLORS PER RIBBONLYTE COLOR

- STATIC WHITE
- Red Wire (+) Positive
- Black Wire (-) Negative