



PERFORMANCE AT 3500K

OUTPUT	DISTRIBUTION	NOMINAL LUMEN OUTPUT		INPUT WATT	EFFICACY
		INDIRECT	DIRECT		
LH (High)	SYMMETRIC	-	1297 lm / ft	12 W / ft	106 lm / W
	BATWING WIDE	1375 lm / ft	-	12 W / ft	113 lm / W
	ASYMMETRIC (ASI & ASO)	1383 lm / ft	-	12 W / ft	113 lm / W
LS (Standard)	SYMMETRIC	-	649 lm / ft	6 W / ft	106 lm / W
	BATWING WIDE	687 lm / ft	-	6 W / ft	113 lm / W
	ASYMMETRIC (ASI & ASO)	692 lm / ft	-	6 W / ft	113 lm / W

Based on static white 35K HE lens fixtures. For the complete photometric data of this fixture refer to page 4.

LENS OPTIONS

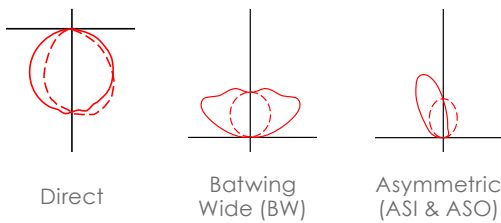

PATTERN OPTIONS

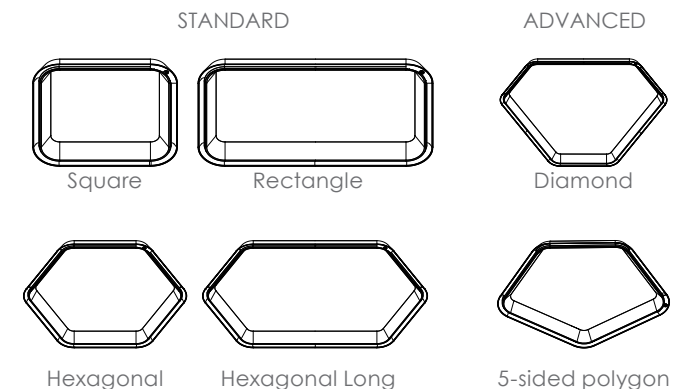

RELAY

Direct & Indirect - Pendant system

With curved & softened design elements, configure diverse geometric patterns for a continuously lit shape. Uplight, downlight or both, Relay gives you the freedom to realize your lighting ambitions.

- Fully lit corners for seamless illumination.
- Various pattern options for design freedom.
- High performance, low glare, direct-indirect light source.
- Multiple indirect distributions.
- Fixture mounted nLight® compatible sensors.
- Acoustic infill options available.

DIMENSIONS

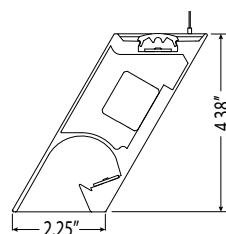

Cross Section

MOUNTING OPTIONS

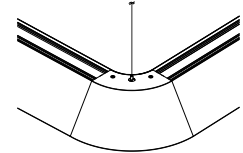

(S) | Aircraft cable

FELT OPTIONS

Standard Colors



Premium Colors



Color chart for reference only. Due to the dye process, colors may vary from batch to batch, please consult Design Assist for details.

SQUARE PATTERN: SQ

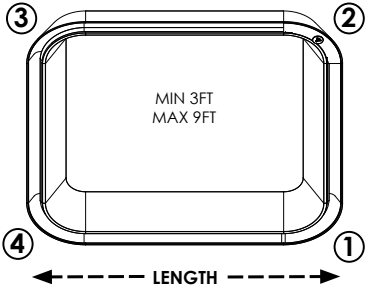

HEXAGONAL PATTERN: H

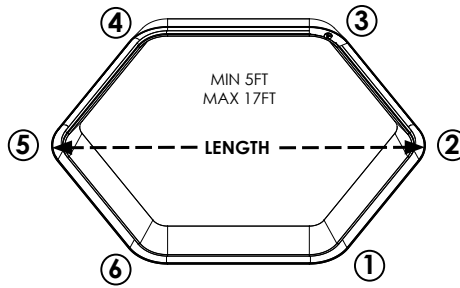

*The corners are numbered clockwise from the power cable.

**Unless specified otherwise, the power cable is placed on corner 1.

*** This shows bottom view.

RECTANGLE PATTERN: RC

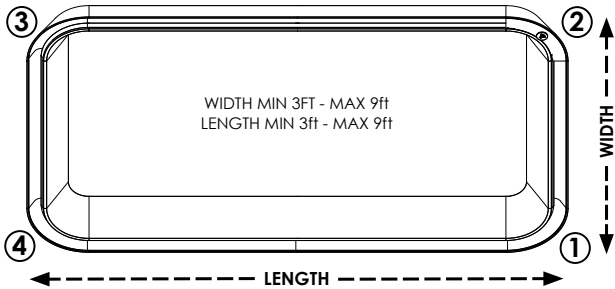

HEXAGONAL LONG PATTERN: HL

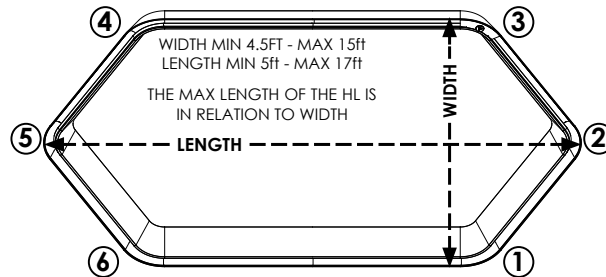

ORDERING CODE

RLY2		S
------	--	---

PROJECT INFO

DATE

TYPE

QUANTITY

SERIES	PATTERN	DIMENSION	OUTPUT	LED CCT	LED CRI	VOLTAGE	INDIRECT DISTRIBUTION	MOUNTING
RLY2	H Hex HL Hex Long SQ square RC Rectangle AD Advanced*	L_ Length W_ Width *Outside lengths are adjustable to the nearest 6in, for dimension references go to pages 5 & 6. (EX: L8W5.5) **Smallest nominal length 3ft. ***For a H and a SQ give only the length dimension. (EX: L5 for 5ft length HEX)	ILS Indirect LED Standard Output ILH Indirect LED High Output IC_ Indirect LED Custom Output* + DLS Direct LED Standard Output DLH Direct LED High Output DC_ Direct LED Custom Output*	27 2700K 30 3000K 35 3500K 40 4000K TW Tunable white* (2700k to 5000k) DW Dim to warm* (2700k to 5000K)	— CRI 80 CRI CRI 90+ Standard offering is 80+ CRI. *90+ CRI is not available with Tunable white and Dim to warm.	U 120V-277V 3 347V	BW Batwing Wide ASI Asymmetric in* ** ASO Asymmetric out* *** *Tunable white and Dim to warm is not available with BW, ASI, and ASO indirect distributions. **Asymmetric optic is oriented so most of the light is inside the fixture. ***Asymmetric optic is oriented so most of the light is outside the fixture.	S Aircraft Cable* *Standard 48" field adjustable cable, specify length to the nearest inch if over 48". Black power cord provided for black and titanium finish and white power cord provided for all other fixture finishes, unless otherwise specified.

FINISH	CIRCUITING	DIMMING	EMERGENCY	SENSOR	SENSOR PLACEMENT	POWER CABLE PLACEMENT	OPTIONS
B Black W White T Titanium O_ Other* <div style="display: flex; flex-direction: column; gap: 5px;"> <div> CBD</div> <div> SFH</div> <div> SDW</div> <div> LME</div> <div> SPN</div> <div> SMN</div> <div> SCY</div> </div> <p>*Specify RAL#</p>	1 Single Circuit 2 Multi-Circuit** M Other Multi-Circuit**	D Standard 0-10 dimming* D1 HiLume Ecosystems 1% D2 Phase dimming** D4 DALI (dim-to-off) NAIR nLight @AIR (dim-to-off)*** NWIR nLight @Wired (dim-to-off)	EC Emergency circuited E_ Emergency battery* *Factory-installed emergency battery pack. Not available on SQ fixtures smaller than 4ft and H fixtures smaller than 6ft. See technical data or contact Design Assist for more information.	OF Occupancy Sensor on Fixture PF Photocell / Daylight Sensor on Fixture OPF Occupancy & Daylight Sensor on Fixture	S1 Corner 1 S2 Corner 2 S3 Corner 3 S4 Corner 4 S5 Corner 5 S6 Corner 6	C1 Corner 1 C2 Corner 2 C3 Corner 3 C4 Corner 4 C5 Corner 5 C6 Corner 6	F1 Felt infill 1 layer** F2 Felt infill 2 layer** **Specify felt colors, see page 10. See page 9 or Consult Design Assist for more information.

LIGHT DISTRIBUTION

DISTRIBUTION

Direct
 Indirect Batwing wide
 Indirect Batwing extra-wide
 Indirect Asymmetric in & out

OUTPUT (DC)

LH: High output - 12 W/ft
 LS: Standard output - 6 W/ft
 C: Custom tuned output - Contact Design Assist

PERFORMANCE AT 3500K

OUTPUT	DISTRIBUTION	NOMINAL LUMEN OUTPUT		INPUT WATT	EFFICACY
		INDIRECT	DIRECT		
LH <small>(High)</small>	SYMMETRIC	-	1297 lm / ft	12 W / ft	106 lm / W
	BATWING WIDE	1375 lm / ft	-	12 W / ft	113 lm / W
	ASYMMETRIC (ASI & ASO)	1383 lm / ft	-	12 W / ft	113 lm / W
LS <small>(Standard)</small>	SYMMETRIC	-	649 lm / ft	6 W / ft	106 lm / W
	BATWING WIDE	687 lm / ft	-	6 W / ft	113 lm / W
	ASYMMETRIC (ASI & ASO)	692 lm / ft	-	6 W / ft	113 lm / W

Based on static white 35K. For the complete photometric data of this fixture refer to page 4.

PHOTOMETRIC DATA

DIRECT

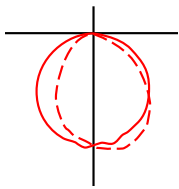

LH - 3500K

Lumens: 1297 lm/ft
 Input watts: 12 W/ft
 Efficacy: 106 lm/W

DLH: —

INDIRECT BATWING WIDE

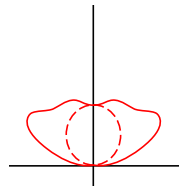

LH - 3500K

Lumens: 1375 lm/ft
 Input watts: 12 W/ft
 Efficacy: 113 lm/W

ILH: —

INDIRECT ASYMMETRIC
 (ASI & ASO)

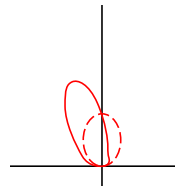

LH - 3500K

Lumens: 1383 lm/ft
 Input watts: 12 W/ft
 Efficacy: 113 lm/W

ILH: —

LIGHT LOSS FACTORS (LLF)

OUTPUT	CCT	LLF RATIO		DIRECT		INDIRECT			
						BATWING WIDE		ASYMMETRIC (ASI & ASO)	
		CRI 80+	CRI 90+	CRI 80 +	CRI 90 +	CRI 80 +	CRI 90 +	CRI 80 +	CRI 90 +
LH <small>(high)</small>	4000k	102.1%	90.4%	1324 lm/ft	1172 lm/ft	1404 lm/ft	1243 lm/ft	1413 lm/ft	1248 lm/ft
	3500k	100%	87.5%	1297 lm/ft	1135 lm/ft	1375 lm/ft	1203 lm/ft	1383 lm/ft	1207 lm/ft
	3000k	96.3%	82.8%	1249 lm/ft	1074 lm/ft	1324 lm/ft	1139 lm/ft	1331 lm/ft	1140 lm/ft
	2700k	92.7%	78.6%	1202 lm/ft	1019 lm/ft	1275 lm/ft	1081 lm/ft	1280 lm/ft	1081 lm/ft
LS <small>(standard)</small>	4000k	102.1%	90.4%	663 lm/ft	587 lm/ft	701 lm/ft	621 lm/ft	707 lm/ft	624 lm/ft
	3500k	100%	87.5%	649 lm/ft	568 lm/ft	687 lm/ft	601 lm/ft	692 lm/ft	603 lm/ft
	3000k	96.3%	82.8%	625 lm/ft	537 lm/ft	662 lm/ft	569 lm/ft	666 lm/ft	570 lm/ft
	2700k	92.7%	78.6%	602 lm/ft	510 lm/ft	637 lm/ft	540 lm/ft	640 lm/ft	540 lm/ft

FULL FIXTURE OUTPUT

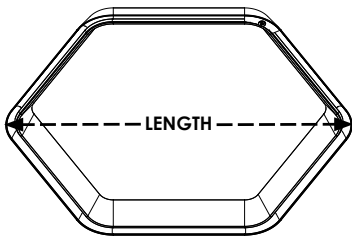

DISTRIBUTION	CCT	H - HEXAGONAL					
		5FT	7FT	9FT	11FT	13FT	15FT
		CRI 80 +	CRI 80 +	CRI 80 +	CRI 80 +	CRI 80 +	CRI 80 +
DIRECT SYMMETRIC	3500k	19,455 lm	27,237 lm	35,019 lm	42,801 lm	50,583 lm	58,365 lm
INDIRECT BATWING WIDE	3500k	20,625 lm	28,875 lm	37,125 lm	45,375 lm	53,625 lm	61,875 lm
INDIRECT ASYMMETRIC	3500k	20,745 lm	29,043 lm	37,341 lm	45,639 lm	53,937 lm	62,235 lm

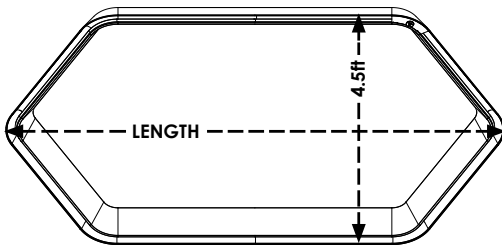

DISTRIBUTION	CCT	HL - HEXAGONAL LONG					
		5FT	7FT	9FT	11FT	13FT	15FT
		CRI 80 +	CRI 80 +	CRI 80 +	CRI 80 +	CRI 80 +	CRI 90 +
DIRECT SYMMETRIC	3500k	19,455 lm	24,643 lm	29,831 lm	35,019 lm	40,207 lm	45,395 lm
INDIRECT BATWING WIDE	3500k	20,625 lm	26,125 lm	31,625 lm	37,125 lm	42,625 lm	48,125 lm
INDIRECT ASYMMETRIC	3500k	20,745 lm	26,277 lm	31,809 lm	37,341 lm	42,873 lm	48,405 lm

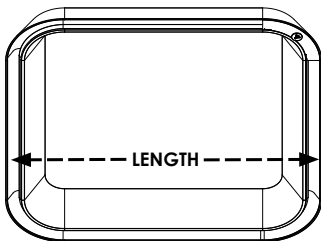

DISTRIBUTION	CCT	SQ - SQUARE			
		3FT	5FT	7FT	9FT
		CRI 80 +	CRI 80 +	CRI 80 +	CRI 80 +
DIRECT SYMMETRIC	3500k	12,970 lm	23,346 lm	33,722 lm	44,098 lm
INDIRECT BATWING WIDE	3500k	11,000 lm	22,000 lm	33,000 lm	44,000 lm
INDIRECT ASYMMETRIC	3500k	11,064 lm	22,128 lm	33,192 lm	44,256 lm

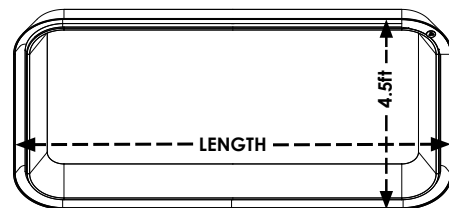

DISTRIBUTION	CCT	RC - RECTANGLE			
		3FT	5FT	7FT	9FT
		CRI 80 +	CRI 80 +	CRI 80 +	CRI 80 +
DIRECT SYMMETRIC	3500k	16,861 lm	22,049 lm	27,237 lm	32,425 lm
INDIRECT BATWING WIDE	3500k	15,125 lm	20,625 lm	26,125 lm	31,625 lm
INDIRECT ASYMMETRIC	3500k	15,213 lm	20,745 lm	26,277 lm	31,809 lm

Factors above for high output (LH).
 For standard output (LS) -50%.
 Refer to the LLF table to get other CCT output.
 *If you need the output of a specific size call Design Assist.

RELAY 3 | SQUARE DIMENSION

NOMINAL RELAY SQUARE DIMENSIONS							
	NOMINAL 3'	NOMINAL 4'	NOMINAL 5'	NOMINAL 6'	NOMINAL 7'	NOMINAL 8'	NOMINAL 9'
TRUE DIMENSION	38.32''	50.32''	62.32''	74.32''	86.32''	98.32''	110.32''
MOUNTING LENGTH DIMENSION	28.44''	40.44''	52.44''	64.44''	76.44''	88.44''	100.44''
LIT LENGTH	24.00''	36.00''	48.00''	60.00''	72.00''	84.00''	96.00''

*Outside lengths are specifiable to the nearest 0.5ft.

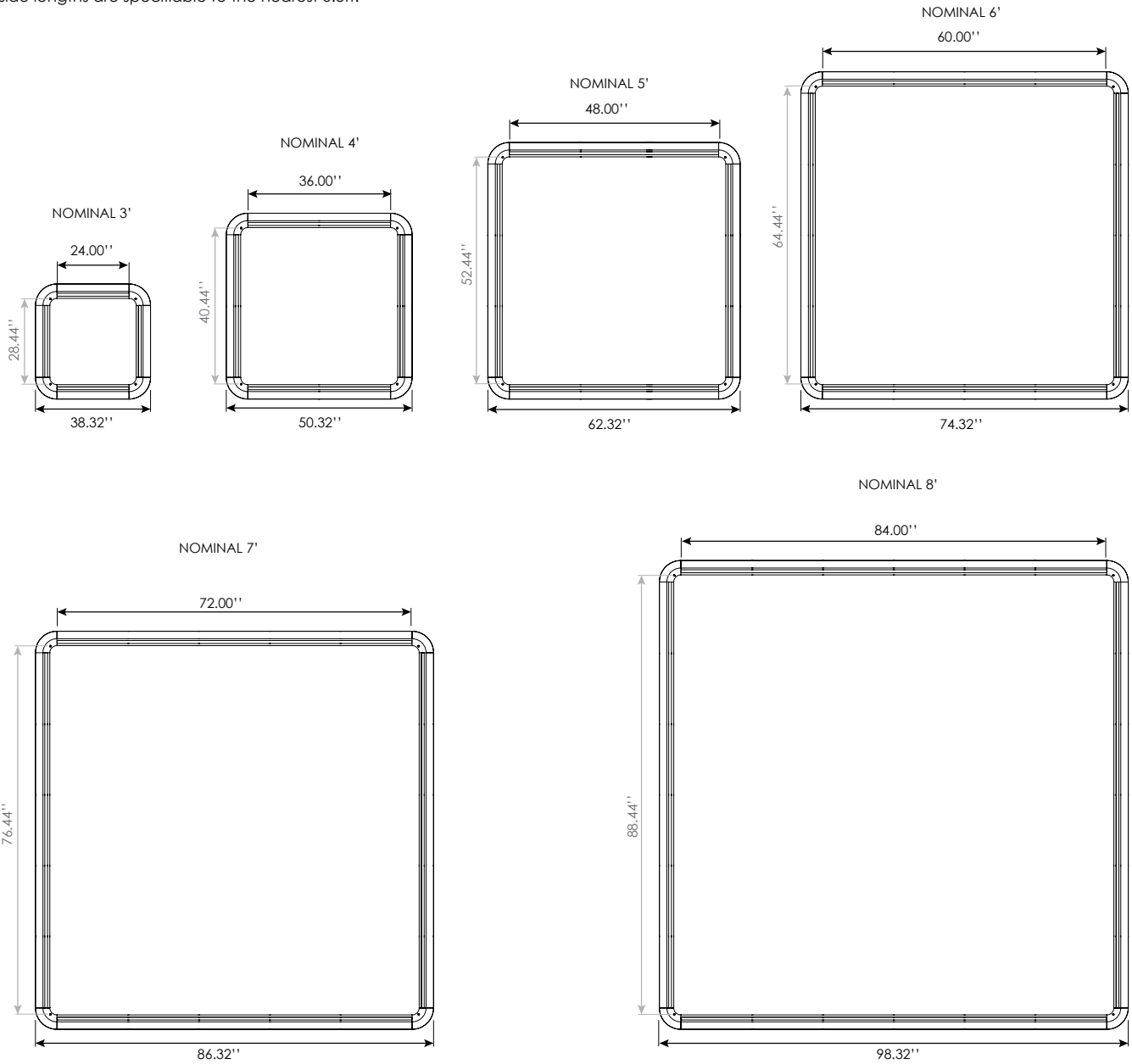

*Dimensions in grey are the mounting point lengths.

RELAY 2 | HEXAGONAL DIMENSION

NOMINAL RELAY HEXAGONAL DIMENSIONS											
	NOMINAL 5'	NOMINAL 6'	NOMINAL 7'	NOMINAL 8'	NOMINAL 9'	NOMINAL 10'	NOMINAL 11'	NOMINAL 12'	NOMINAL 13'	NOMINAL 14'	NOMINAL 15'
TRUE LENGTH DIMENSION	63.32''	75.32''	87.32''	99.32''	111.32''	123.32''	135.32''	147.32''	159.32''	171.32''	183.32''
TRUE WIDTH DIMENSION	56.88''	67.27''	77.67''	88.06''	98.45''	108.84''	119.23''	129.63''	140.02''	150.41''	160.80''
MOUNTING LENGTH DIMENSION (A)	27.75''	33.75''	39.75''	45.75''	51.75''	57.75''	63.75''	69.75''	75.75''	81.75''	87.75''
MOUNTING LENGTH DIMENSION (B)	55.50''	67.50''	79.50''	91.50''	103.50''	115.50''	127.50''	139.50''	151.50''	163.50''	175.50''
MOUNTING LENGTH DIMENSION (C)	48.00''	58.44''	68.85''	79.25''	89.60''	100.00''	110.40''	120.80''	131.20''	141.60''	152.00''

*Outside lengths are specifiable to the nearest 0.5ft.

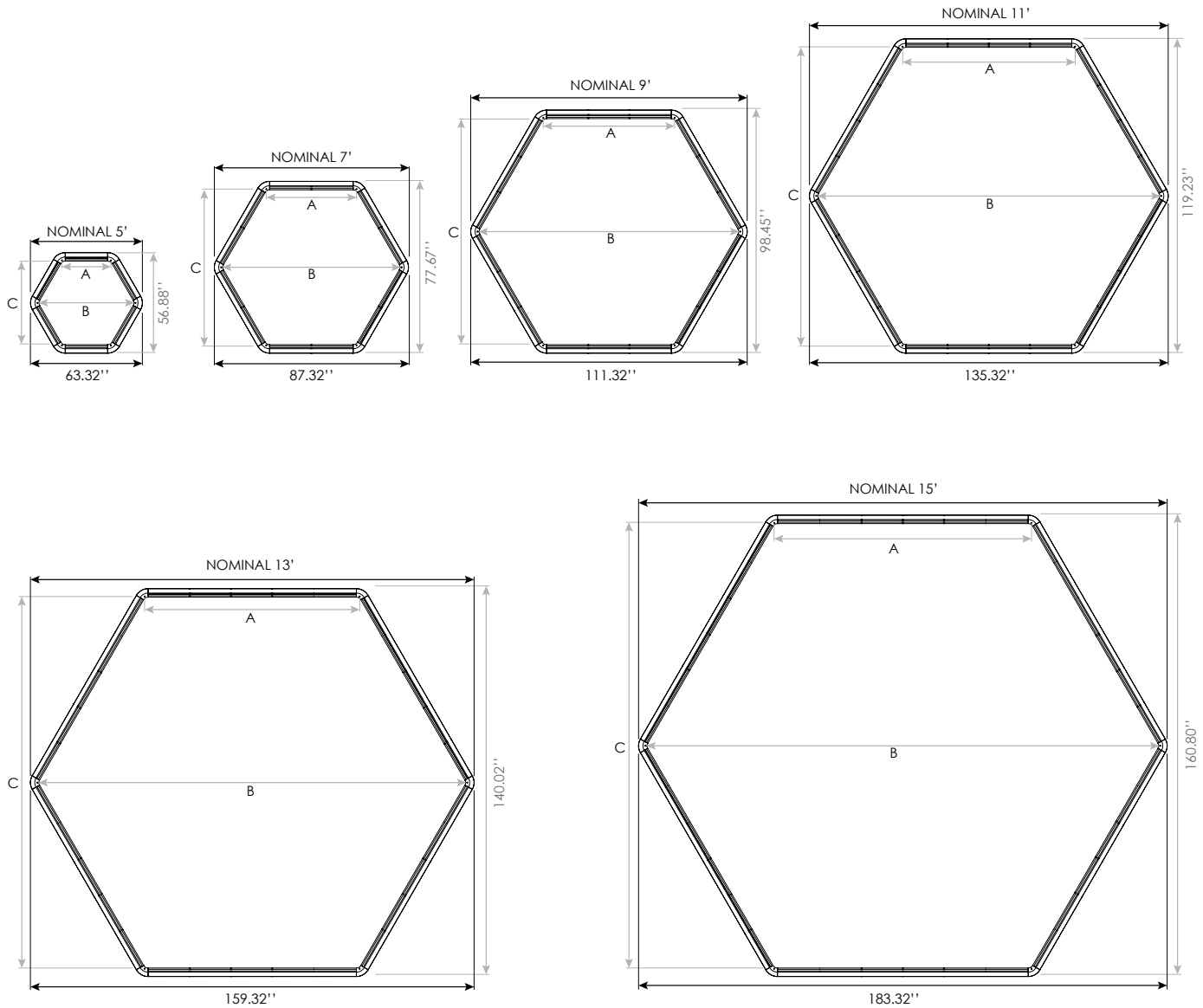

*Dimensions in grey are the mounting point lengths.

STANDARD PATTERN

HEXAGONAL PATTERN:

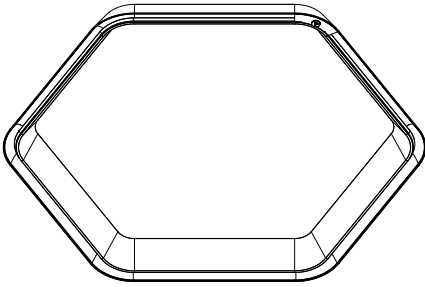

The Hex pattern comes with 6 X 120° corners and 6 extrusions segments, which are available in multiple lengths to alter the shape.

HEXAGONAL LONG PATTERN:

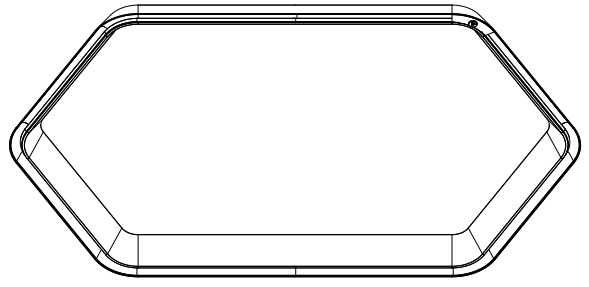

The hexagonal long pattern comes with 6 X 120° corners and 4 shorts extrusions and 2 longs extrusions segment, which are available in multiple lengths to alter the shape.

SQUARE PATTERN:

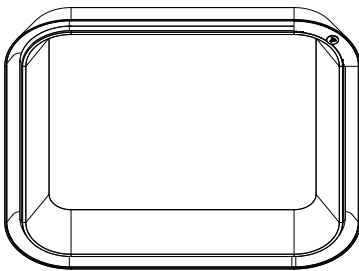

The square pattern comes with 4 X 90° corners and 4 extrusions segments, which are available in multiple lengths to alter the shape.

RECTANGLE PATTERN:

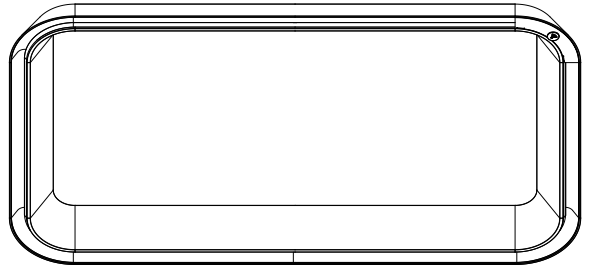

The rectangle pattern comes with 4 X 90° corners and 4 extrusions segments, which are available in multiple lengths to alter the shape.

ADVANCED PATTERN

DIAMOND PATTERN:

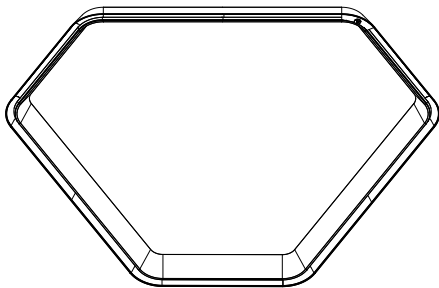

The diamond pattern comes with 6 X 120° corners and 3 shorts extrusions and 3 longs extrusions segment, which are available in multiple lengths to alter the shape.

5-SIDED POLYGON PATTERN:

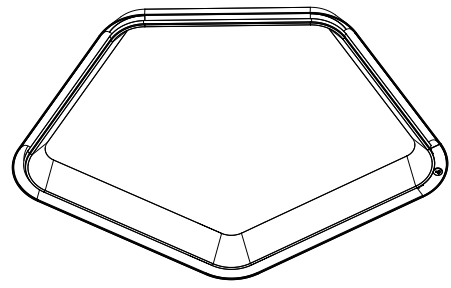

The 5-sided polygon pattern comes with 3 X 120° and 2 X 90° corners and 3 shorts extrusions and 2 longs extrusions segment, which are available in multiple lengths to alter the shape.



Need help?

Don't see what you need?

We know that having so many options can be overwhelming. Please reach out to our factory for any specific request or questions you have. Our talented Design Assist team is here to make the process move smoothly.

nLIGHT® DIMENSIONS

AIR : r10

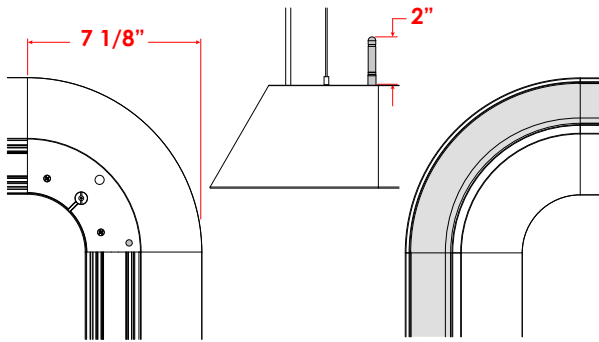

*Fixture mounted sensors and filler panel for nLIGHT® AIR only.

AIR : res7

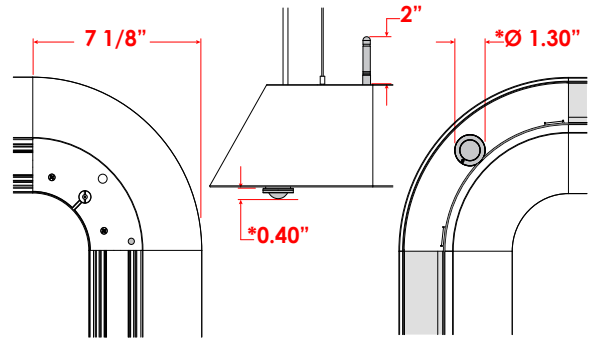

*Fixture mounted sensors and filler panel for nLIGHT® AIR only.

FELT INTEGRATION OPTIONS

1 LAYER ACOUSTIC PANEL:

The acoustic panels ship on the side with all appropriate mounting brackets for easy installation on site. Simply hook and screw the acoustic panels to the fixture body. The colour of the felt bracket will match the colour of the extrusion. Please visit the installation guide for more information.

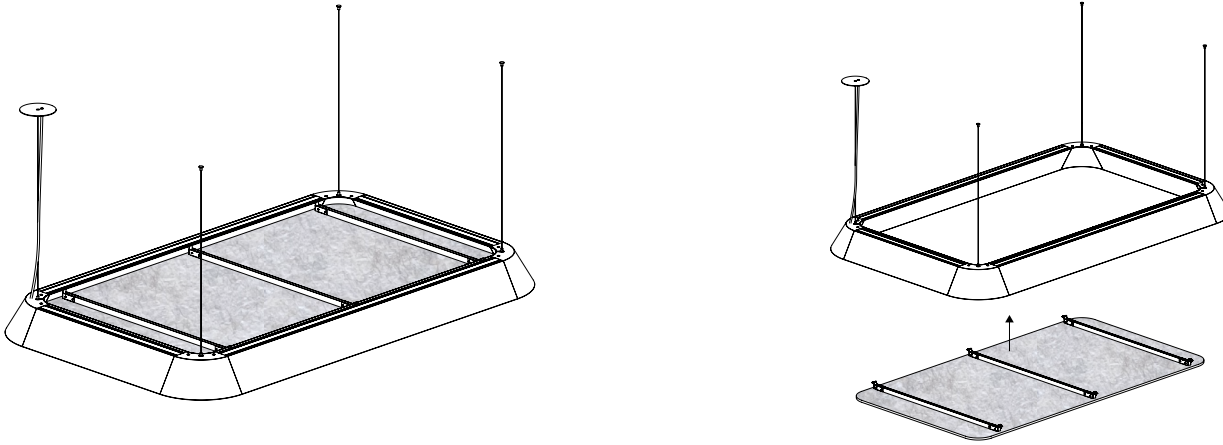

2 LAYERS ACOUSTIC PANEL:

The 2-layer acoustic panel comes with the 1-layer felt panel and an additional drop-in-place acoustic panel that goes over the structure. This panel is used to hide the acoustic panel structure and to give a better finish on the upside of the fixture.

We recommend the use of the 2 layers acoustic panel integration where the upside of the fixture is visible.

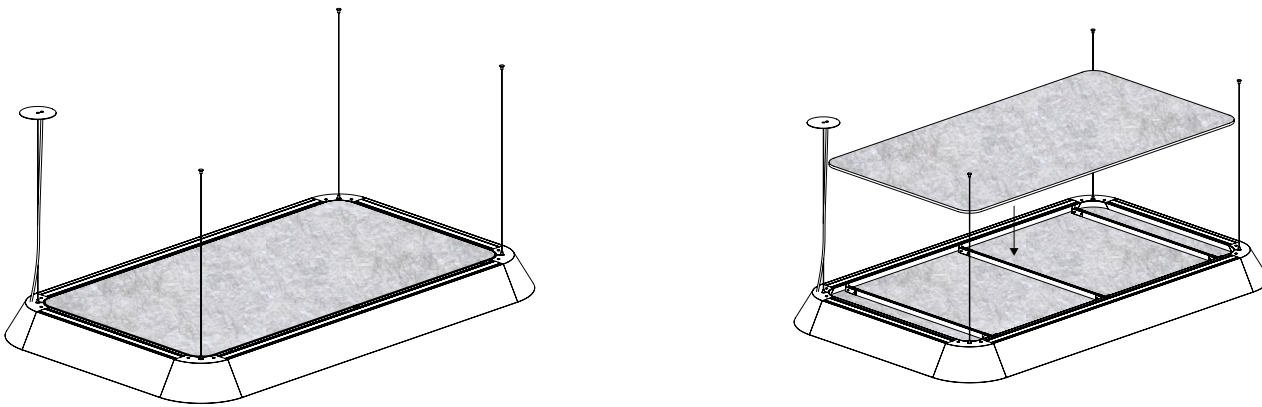

FIXTURE SIZE COMPATIBLE WITH ACOUSTIC

PATTERN TYPE	MINIMUM NOMINAL SIZE	MAXIMUM NOMINAL SIZE
Hexagonal	5'	9'
Hexagonal long	5' X 5'	9' X 8'
Square	3'	9'
Rectangle	3' X 3'	9' x 9'
Diamond	Contact Design Assist	
Pentagon		

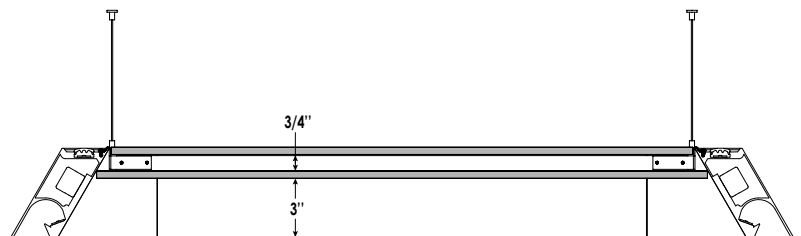

Standard Colors



ABF
Azure Blue

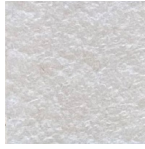

AWF
Arctic White

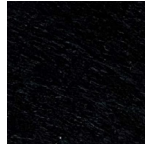

BBF
Basic Black



BOF
Blood Orange

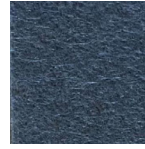

BTF
Battleship Grey



BYF
Banana Yellow



CHF
Charcoal



NSF
Navy Blue



OBF
Ocean blue

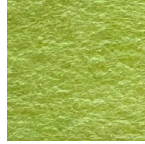

PGF
Pear Green

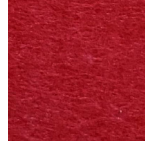

REF
Red



SGF
Silver Grey

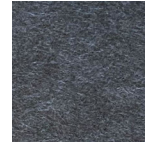

TGF
Titanium Gray



ZFF
Zinfandel

Premium Colors



BGF
Bubble Gum



BKF
Dark Brown

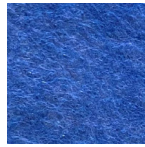

DBF
Denim Blue



DTF
Deep Teal Green



DYF
Daisy Yellow

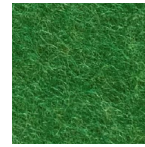

GGF
Grass Green



LBF
Light Beige



LGF
Lime Green

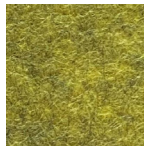

MGF
Moss Green



OAF
Oak Brown



PBF
Peanut Brown

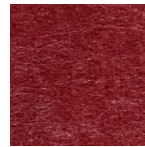

PNF
Pinot Noir



PPF
Plum Purple

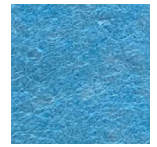

SBF
Sky Blue



TOF
Tangerine



TPF
Tulip Purple

Color chart for reference only. Due to the dye process, colors may vary from batch to batch, please consult Design Assist for details.

DIMENSIONS

The Relay is a combination of linear profiles and angled corners. The linear segments can vary in length, in increments of 6in, from a minimum length of 2ft to a maximum length of 8ft. The angled corner options are 120° and 90°. Combining these elements enables the creation of multiple shapes and patterns. Exact lengths down to the 1" are not available.

OPTICS

Direct: The light source is reflected off a high-performance specialty film to render a smooth, powerful and controls output. The light engine design enables an uninterrupted line of light all around the profile.

Indirect: High efficiency TIR lenses are used to provide high quality precision optics. The output option offered are Batwing wide, Batwing Extra-Wide, Asymmetric in (to orient light inside the profile) and Asymmetric out (to orient light outside the profile).

LED LIGHT SOURCE

Custom manufactured round and linear boards array uses high-performance Nichia® LED in combination with a performance-driven heat sink technology. Tested in accordance with LM-79 and LM-80; L70>60,000hr; operated at reduced output for high efficacy and lumen maintenance. 2700k, 3000K, 3500K, and 4000K with 80+ CRI standard; other color temperatures and 90+ CRI available upon request, contact factory. White tuning and dim to warm are also available in a 2700k-5000k color temperature range, but not in 90+ CRI. LED color variation maintained at a 3-step MacAdam ellipse (SDCM 3x). Refer to photometry for delivered lumens.

LED DIMMING DRIVER

Factory tuned constant current electronic 0-10V control dimming driver is standard. Specification grade dimming down to 1%. Driver life of 50,000 hrs with an ambient operating temperature range of -30°C to 50°C, maximum case temperature of 75°C. Electrical specifications at maximum driver load: PF >0.9, THD <20%, >85% Efficiency. Other available drivers include Lutron Eco-system H-series (LDE1); Hi-lume™ 1% LED dimming driver with Soft On, Fade to Black; and DALI protocol drivers. Other Lutron and specialty drivers available, contact factory.

EMERGENCY

Factory-installed integrated fixture LED emergency battery pack for both normal and emergency operation, with the exception of the 2ft extrusion fixture (SQ fixture smaller than 4ft and H fixture smaller than 6ft) which must have a remote emergency battery. The unit contains a long-life Ni-Cad recyclable battery, 24-hour charger, and converter circuit. Test switch and charge indicator provided. Emergency mode provides constant power to a nominal 12W or 5W LED load for a period of 90 minutes, delivering 1200 or 500 lumens of unwavering illumination throughout the full 90 minute emergency duration.

Emergency circuiting provided as a separate circuit from normal power circuit according to NEC requirements, specify circuit length and location.

CONTROLS

Low-profile integral occupancy and daylight sensors are available to deliver high-performance lighting control in any space.

Integrated nLight® for system networking wired and wireless:

NLIGHT® AIR WIRELESS

The integrated API smart sensor is part of each luminaire in the nLight® AIR network, which can be grouped to control multiple luminaires. The granularity of control with the digital PIR occupancy detection and daylight sensing makes a great solution for any application. Optionally you can order nLight® AIR less sensors for compatibility with an nLight Air wireless system. The rIO, rES7, rMSOD, and rCMS models are available for integration.

CONTROLS AND SYSTEM NETWORKING OPTIONS

For wired networking via Cat-5e, choose an nLight® wired module. The rPPI6 and nCM are available for integration.

nLight enabled, remote mounted controls provided by others. Please contact an Acuity controls representative for more information.

MOUNTING

Aircraft cable set includes one 48" standard length 1/16 stainless steel adjustable aircraft cables with secure mini grippers to field set suspension length par corners, it comes pre-installed in the fixture by the factory. 4-1/2" round canopy and cord strain relief are also included. Please refer to installation sheets for mounting weight requirements. Power cord options available for aircraft cable. A black power cord is provided for black and titanium finish, a white power cord is provided for all other fixture finishes unless otherwise specified. All canopies are white, unless otherwise noted.

Specify if other suspension length is required.

ACOUSTICS

The felt-like polyester panels are made from at least 40% post-consumer recycled PET bottles and are fully recyclable, no VOCs formaldehyde-free. Fire tested according to ASTM E-84 Class A. The carefully studied hollow core design and the large surface area contribute to lowering the reverberation time in a set environment by absorbing sound frequencies (ideal for human voice range 250Hz to 2000Hz). Material has inherent NRC of 0.75. It is recommended to consult sound professionals for optimal spacing, positioning and quantity of acoustic material for your environment. Due to the dyeing process, colors may vary from batch to batch. Premium colors require a longer lead time. The colour of the felt bracket will match the colour of the extrusion.

STRUCTURE

Robust, high-quality precision recycled aluminum extruded housing. Laser-cut and precision bent sheet metal components and brackets.

FINISH

Electrostatically applied powder coat finish. Standard finish options include titanium, white and black. Other colors and custom finish options available, specify RAL# or contact factory regarding custom finish requirement.

LISTING

Tested in accordance with UL 1598, CSA C22.2 No. 250.0. For USA and Canada. Dry locations only

WARRANTY

Please refer to the full terms and conditions on our website:
<https://www.alights.com/downloads/warranty/>