

# FENESTRA OAK

BOLLARDS

Solar Bollard



# FENESTRA OAK

Designed to last  
No matter the conditions

The FENESTRA OAK is a sleek solar bollard light defined by its clean architectural form and integrated window-like light aperture. Crafted from durable oak wood with protective treatment, it combines natural warmth with modern performance. Featuring an integrated solar panel, energy-efficient LED lighting, and a long-life LiFePO<sub>4</sub> battery, it delivers reliable, fully off-grid illumination. Designed to withstand outdoor conditions while providing focused, subtle lighting, FENESTRA OAK is ideal for pathways, gardens, and contemporary landscape settings.

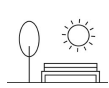

Park & Garden

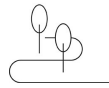

Hiking Trails



Places

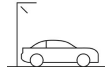

Car Park & Rest

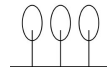

Pathways



Campsites

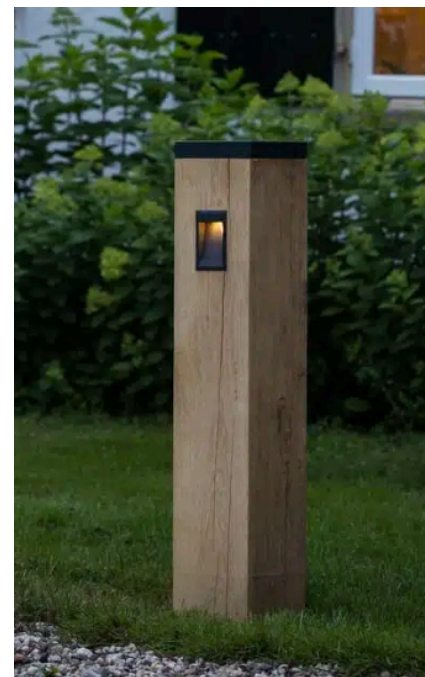
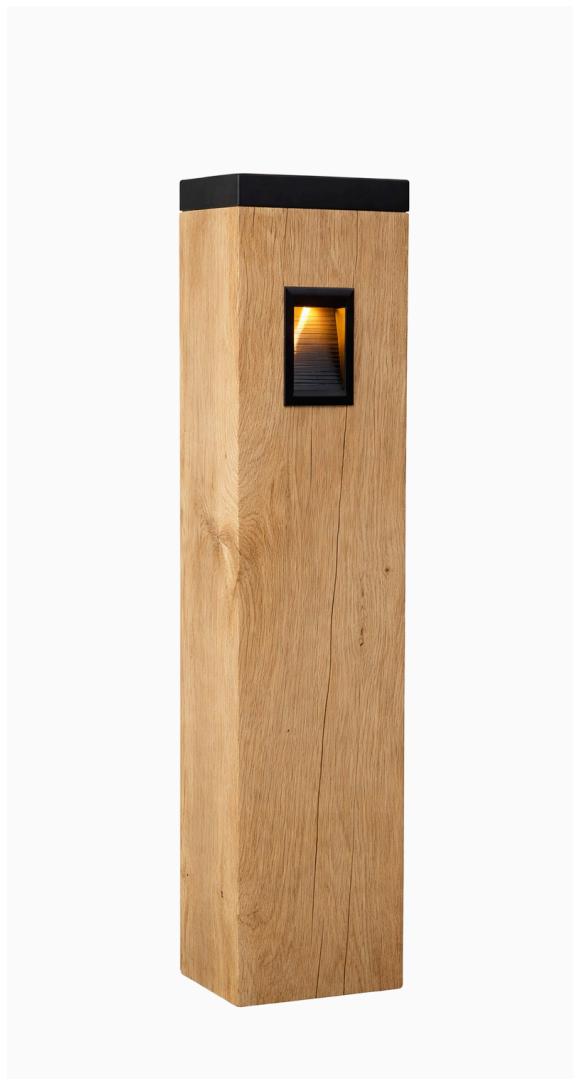

# FENESTRA OAK

FIXTURE TYPE: \_\_\_\_\_

PROJECT NAME: \_\_\_\_\_



**MATERIAL:**

Oak

**LIGHTING:**

LED

**BATTERY:**

Lithium Iron Phosphate LIFEPO4 44Wh

**ENERGY:**

Solar powered, fully off-grid with integrated solar panel (no external power required).

**SOLAR PANEL:**

Reinforced Glass solar-panel

**MECHANICAL:**

Oak wood body with anti-rot protection, integrated solar top housing, and durable outdoor construction designed to withstand weather conditions.

**LIGHT WIDTH:**

Approximately 6 meters per side

**UPWARD LIGHT RATIO (ULR):**

0%

**BURN TIME:**

8 - 12 hours

**TEMPERATURE:**

-20...+50°C

**LIFESPAN:**

15 – 25 years

**CERTIFICATIONS:**

PEFC, The Forest Stewardship Council (FSC)

**BEAM ANGLE:**

105x50

**APPLINCE CLASS:**

II



Bullard Solar retains the right to modify or change product specifications without prior notice, as part of our ongoing commitment to improvement



Due to the dynamic nature of lighting products and the associated technologies, luminaire data on all specification sheets is subject to change at the discretion of Gordon Bullard LLC and associated companies.

ONE WITH THE SUN

sales@gordonbullard.com / www.bullardbollards.com / 1-877-964-4646

991 South Gull Lake Dr Richland, MI 49083 USA

# FENESTRA OAK

FIXTURE TYPE: \_\_\_\_\_

PROJECT NAME: \_\_\_\_\_

## HOW TO ORDER:

CODE:

Example:  
CODE: BS-FNSTOK-TL-L1-22K-NON

BS-FNSTOK-TL-  
L1-22K-NON

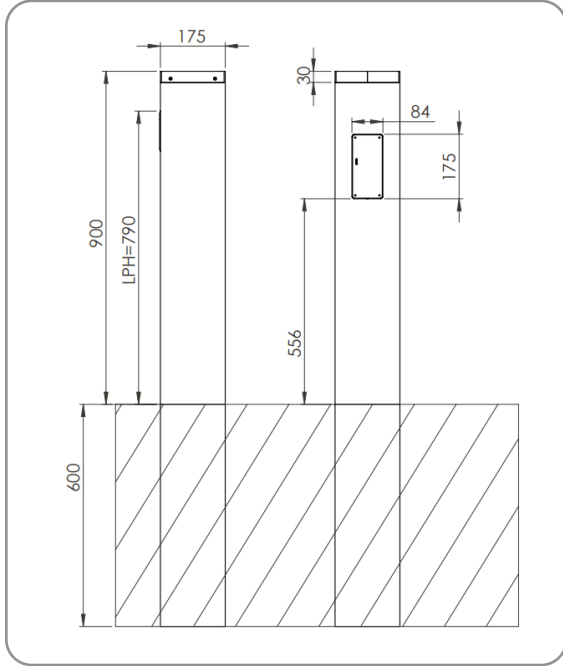

### 1 DIMENSIONS:

Height - H: 35.4" (90 cm)  
Ground level - H: 23.6" (60 cm)  
Width x Length - W x L: 6.9" (17.5 cm)

### 2 LIGHTING SOURCE:

-L1 LED / 3,6W / 110-277V  
-L2 LED / 3,2W / 110-277V

### 3 CCT / LUMENS / CRI:

-27K 2700K / 74 lm / 84CRI (FOR L1)  
-40K 4000K / 103 lm / 72CRI (FOR L1)  
-AMB AMBER 593 nm / 32 lm (FOR L2)

### 4 DIMMING OPTIONS:

-NON NON-Dimmable  
-DIM 0-10V



Due to the dynamic nature of lighting products and the associated technologies, luminaire data on all specification sheets is subject to change at the discretion of Gordon Bullard LLC and associated companies.

ONE WITH THE SUN

sales@gordonbullard.com / www.bullardbollards.com / 1-877-964-4646

991 South Gull Lake Dr Richland, MI 49083 USA